

TARIFA

MARZO 2022

FRANCO DE PORTES

en acondicionado de Francia,
España, Italia o Portugal.



MITJAVILA

KIT PORTALES Y VALLAS

Fencing and Gates KIT

KIT Portails & Clôtures

KIT Cancelli e recinzioni

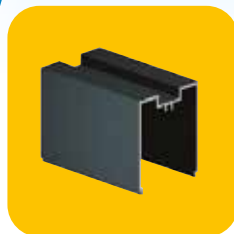

ED:07/22

2022



Publicado justo a tiempo, en las instalaciones de Mitjavila en papel certificado.

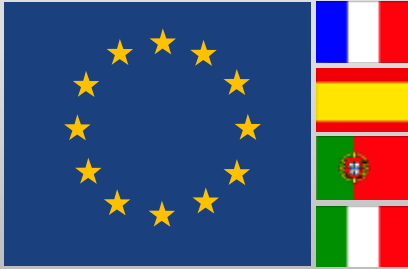

Fabricación Europea / Fabrication Européenne / European manufacturing:

Desde 1970 nuestra empresa realiza la concepción, producción y montaje desde 10 unidades especializadas situadas en el sur de Europa, lo que representa una prueba de garantía y seguridad de suministro para todos nuestros clientes europeos.

Depuis 1970 notre entreprise assure la conception, l'assemblage et la production à partir de 10 Unitads spécialisées situées dans le sud de l'Europe ce qui est aussi un gage de qualité et de sécurité d'approvisionnement pour tous nos clients.

Since 1970 our company has been designing, assembling and producing from 10 specialized units located in the south of Europe, which is also a guarantee of quality and security of supply for all our European customers.

100% aluminio reciclable, 100% Aluminium recyclable, 100% recyclable aluminum

Todos nuestros armazones se componen de piezas y perfiles de aluminio totalmente desmontables y reciclables.

Toutes nos armatures sont composés de pièces, composants et profilés en aluminium et sont entièrement démontables et recyclables.

All our frames, parts and profiles are made of aluminum and are fully removable and recyclable.

Las normas de producto de la UE, Les Normes produits de l'U.E., EU product estándares

La evaluación de la norma europea se realiza en nuestro departamento técnico. Bajo solicitud especial ésta podrá ser corroborada por un laboratorio nacional de ingeniería civil contra remuneración.



L'évaluation de la norme européenne est réalisée par notre bureau d'études. Sur demande spéciale d'un client, celle-ci pourra être confirmée par un laboratoire national du génie civil contre rémunération.

The evaluation of the European estándar is done by our research department. On special request, it can be confirmed by a national laboratory of civil engineering against payment.

El nota de reparabilidad , Note de réparabilité, The reparability score

Todos nuestros armazones son enteramente desmontables y reparabilidad

Toutes nos armatures sont entièrement démontables et réparables.

All our frames are fully removable and reparability.

TARIF H.T.

Franco de port zone nationale
France
R.N.9 - Km 7 - B.P.99
66602 Rivesaltes cedex-France
Tél : (33) 04.68.38.20.20
Fax: (33) 04.68.38.20.32
www.mitjavila.com

TARIFA sin I.V.A.

Transporte incluido
zona nacional
Portugal
Rua de Industria, Carro Quebrado
3720 PINDELO-PORTUGAL
Tél : (351) 256.86.02.36
Fax : (351) 256.86.02.32

10 MARS 2022



TARIFA sin I.V.A.

Transporte incluido zona nacional
España
Ctra de Figueres a Llers S/N
17730 LLERS (Girone) España
Tél : (34) 972.52.80.87
www.mitjavila.com

PREZZO senza I.V.A.

Porto gratuito zona nazionale
Italia
5060 Vignole Borbera (AL)
Italia - Tel : (+39) 0143 67.333
Fax : (+39) 0143 67.145



KIT PORTAL CORREDERO / Ciego 6

SLIDING GATE / Full - PORTALE CORREDERA / KIT PORTAL CORREDERO
/ Completo - CANCELLO SCORREVOLE / completo



KIT PORTAL CORREDERO / Mixto 8

SLIDING GATE / Mixed - PORTALE CORREDERA / Kit portail CORREDERO
mixte
/ Mixto - CANCELLO SCORREVOLE / Misto



KIT PORTAL DOBLE BATIENTE / Ciego 10

DOUBLE SWING GATES / Full - PORTALE DOBLES BATIENTES / Kit portail
double BATIENTEs / completo - CANCELLO A DOPPIA ANTA / completo



KIT PORTAL DOBLE BATIENTE / Lamas venecianas 10

DOUBLE SWING GATES / Brise view - PORTALE DOBLES BATIENTES / Kit portail
BATIENTEs Venecianos / Lamas venecianas - CANCELLO A DOPPIA ANTA / Con
vista



KIT PORTAL DOBLE BATIENTE / Mixto..... 14

DOUBLE SWING GATES / Mixed - PORTALE DOBLES BATIENTES / Kit portail
BATIENTEs mixte - CANCELLO A DOPPIA ANTA / Misto



KIT PUERTAS PEATONALES / Ciego..... 16

SMALL GATE / full - PUERTAS PEATONALES / Kit portillon Ciego / completo -
PICCOLO CANCELLO / completo



KIT PUERTAS PEATONALES / Lamas venecianas 18

SMALL GATE / Brise view- PUERTAS PEATONALES / Kit portillon Venecianos /
Lamas venecianas - PICCOLO CANCELLO / Con vista



KIT PUERTAS PEATONALES / Mixto 20

SMALL GATE / Brise Mixed - PUERTAS PEATONALES / Kit portillon mixte /
Mixto - PICCOLO CANCELLO / Misto

KIT VALLAS Ranch..... 24

RANCH FENCE - VALLA RANCH
FENCE RANCH- RECINZIONE RANCH

KIT VALLAS Lamas venecianas 28

BRISE VIEW FENCE - VALLA Venecianos
FENCE BREEZE VUE - RECINZIONE CON VISTA

Información TÉCNICA Y MONTAJE 32

TECHNICAL Información & ASSEMBLIES - Informaciónrmations techniques et mon-
tages InformaciónRMAÇÕES TÉCNICAS E CONJUNTOS - Información TECNICHE E
MONTAGGI

Orden de compra Purchase order - Orden de compra 40

Ordem de Compra - ordinazione d'acquisto





PORTAILS - GATES - PORTALES - CANCELLI

KIT PORTAL CORREDERO | con paneles Ciegos

SLIDING GATE / Full - PORTALE CORREDERA / Kit portail CORREDERO
Ciego / Completo - CANCELLO SCORREVOLE / completo

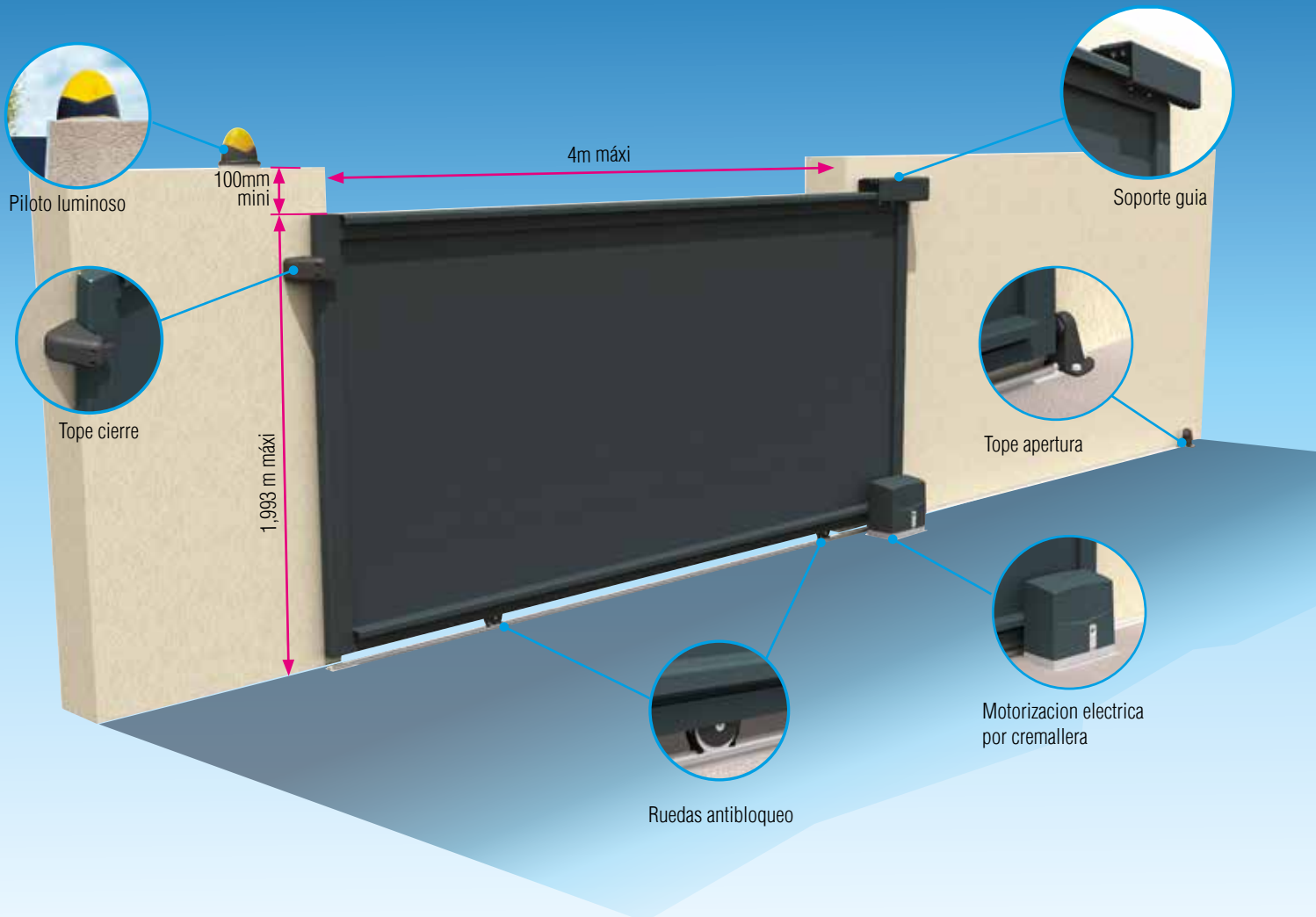

KIT PORTAL CORREDERO

con paneles **Ciegos**

SLIDING GATE / Full - PORTALE CORREDERA / Kit portail CORREDERO
Ciego / Completo - CANCELLO SCORREVOLE / completo



Instalación en superficie

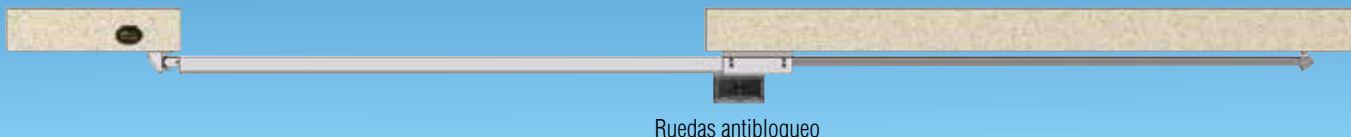

Portal en kit para montar – tarifa H.T.

Incluye : kit SLIDEGATE FIRT + Valor a medida : +20%T

Alto* \ Anchos	3000	3500	4000
1542mm	4 295 €	4 978 €	5 032 €
1692mm	4 490 €	5 165 €	5 238 €
1843mm	4 685 €	5 414 €	5 487 €
1993mm	4 930 €	5 714 €	5 786 €

Información Portal corredero de panel ocultante Sistema de polea sobre rail con perfil de guía en toda la longitud. Motor con cremallera y elementos de seguridad (piloto luminoso, sensores de presencia)

Acabado Acabado Ral. Estándar
RAL 7016 Texturado
RAL 9010 Brillante

Otro ral : +20%
 Opcion : Kit SLIDEGATE HOME : + 135.00 €

* Altura desde el suelo hasta encima del portal.

Atencion ! Añadir 600 mm a la medida de apertura de su pared



Piezas y perfiles



Kit SLIDEGATE FIRST (220 V)
 O Kit SLIGATE HOME (24 V)
 ver página 33

CREM1MP (barra de 1 m,N número de barras proporcionadas según la medida del portal)

KIT PORTAL CORREDERO | con paneles Mixtos

SLIDING GATE / Mixed - PORTALE CORREDERA / Kit Portail CORRE-
DERO Mixte / Mixto - CANCELLO SCORREVOLE / Misto

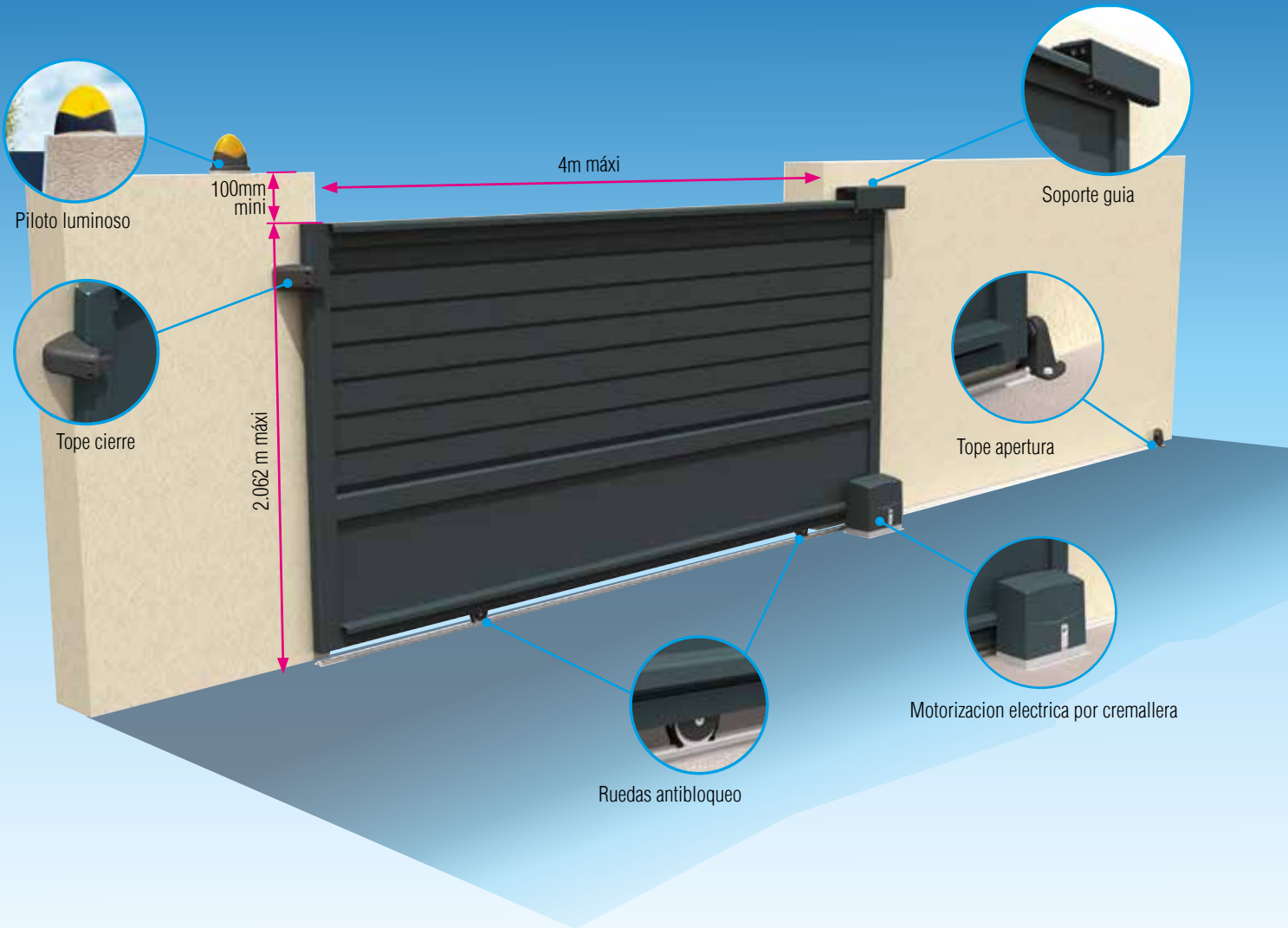

KIT PORTAL CORREDERO | con paneles Mixtos

SLIDING GATE / Mixed - PORTALE CORREDERA / Kit Portail CORRE-
DERO Mixte / Mixto - CANCELLO SCORREVOLE / Misto



Instalación en superficie



Portal en kit para montar – tarifa H.T.

Incluye : kit SLIDEGATE FIRT + Valor a medida : +20%T

Alto* \ Anchos	3000	3500	4000
1594mm	4 366 €	5 056 €	5 109 €
1750mm	4 565 €	5 294 €	5 337 €
1906mm	4 712 €	5 457 €	5 522 €
2062mm	4 907 €	5 692 €	5 757 €

* Altura desde el suelo hasta encima del portal.

Atencion ! Añadir 600 mm a la medida de apertura de su pared

Opcion : Kit SLIDEGATE HOME : + 135.00 €

Información

Portail CORREDERO con paneles Mixto. Sistema de polea sobre rail con perfil de guía en toda la longitud. Motor con cremallera y elementos de seguridad (piloto luminoso, sensores de presencia)

Acabado



Otro ral : +20%



Piezas y perfiles



Kit SLIDEGATE FIRST (220 V)
O Kit SLIGATE HOME (24 V)
ver página 33

CREM1MP (barra de 1 m,N número de barras proporcionadas según la medida del portal)

KIT PORTAL DOBLE BATIENTE | con paneles Ciegos

DOUBLE SWING GATES / Full - PORTALE DOBLES BATIENTES / Kit portail à double BATIENTES panneaux Ciego / completo - CANCELLO A DOPPIA ANTA / completo

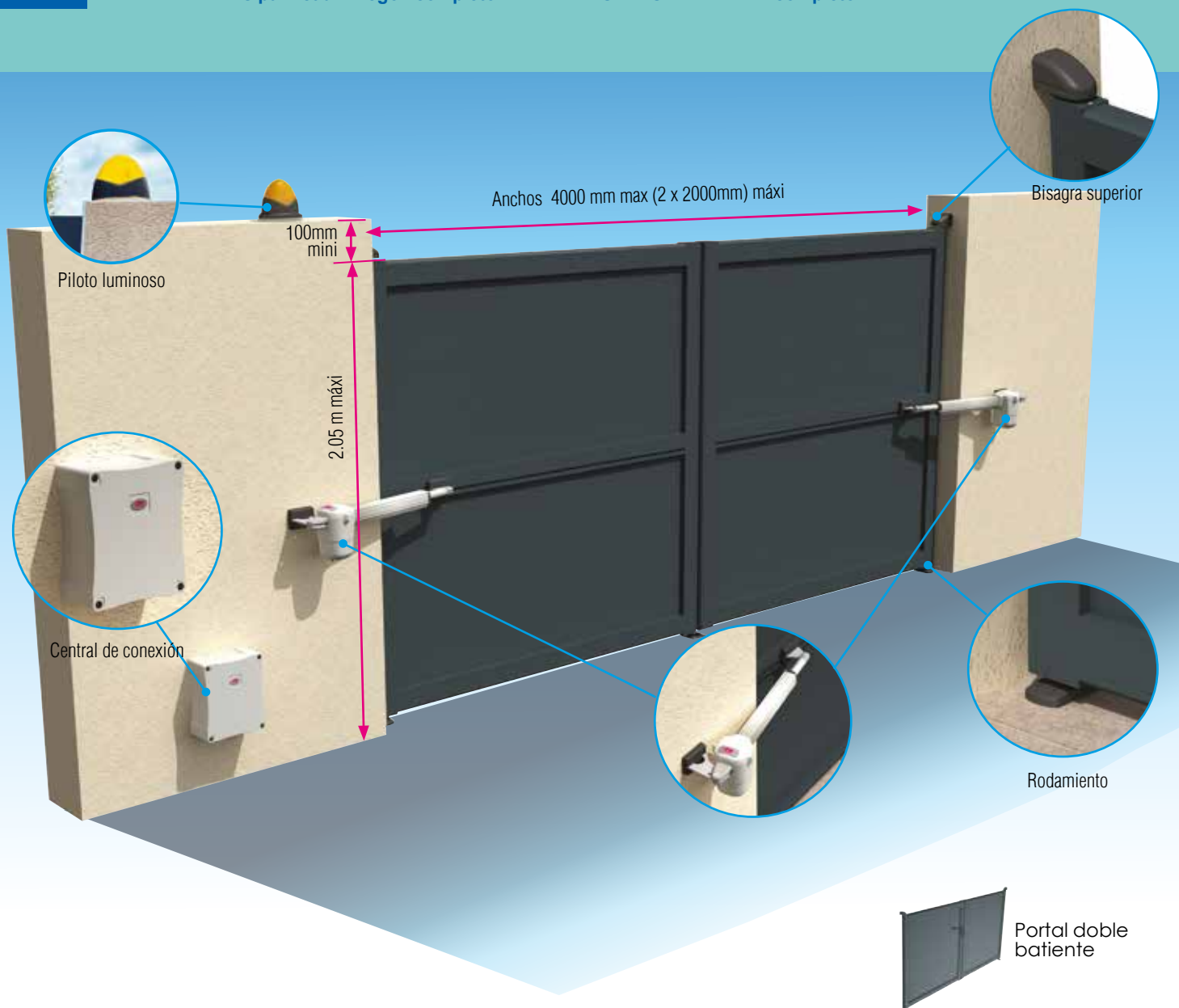

KIT PORTAL DOBLE BATIENTE | con paneles Ciegos

DOUBLE SWING GATES / Full - PORTALE DOBLES BATIENTES / Kit portail à double
BATIENTEs paneaux Ciego / completo - CANCELLO A DOPPIA ANTA / completo



Instalación en fachada



Instalación en tablero únicamente a medida



Portal en KIT para montar doble batiente – Tarifa sin IVA

Incluye : Kit WINGATE FIRST + Valor a medida : +20%T

Alto* \ Anchos entre pilares	3000	3250	3500	3750	4000
1597mm	4 399 €	4 417 €	4 482 €	4 687 €	4 891 €
1747mm	4 703 €	4 721 €	4 786 €	4 991 €	5 195 €
1898mm	5 030 €	5 054 €	5 117 €	5 334 €	5 552 €
2047mm	5 167 €	5 206 €	5 268 €	5 497 €	5 728 €

* Altura desde el suelo hasta encima del portal. Opción: Kit WINGATE HOME : + 610.00 €



Información

Portal de aluminio doble batiente con paneles, motorizado con medidas de seguridad. Instalación simple gracias a las bisagras y los rodamientos.

Acabado

- Acabado Ral. Estándar
- RAL 7016
- Texturado
- RAL 9010
- Brillante
- Otro ral : +20%

Piezas y perfiles



PPC06



PPC02

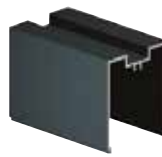

PPC01

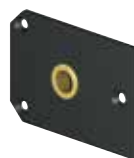

EBPPC02



EBPPC01



PB0602



KIT WINGATE FIRST
Motor con brazo 220 V
Ver página 36



PPC05



CHP23



CHP21



CHP22

| KIT PORTAL DOBLE BATIENTE | con paneles **Lamas venecianas**

DOUBLE SWING GATES / Brise view - PORTALE DOBLES BATIENTES / Kit portail double BATIENTEs à panneaux semi-ajourée / Lamas venecianas - CANCELLO A DOPPIA ANTA / Con vista

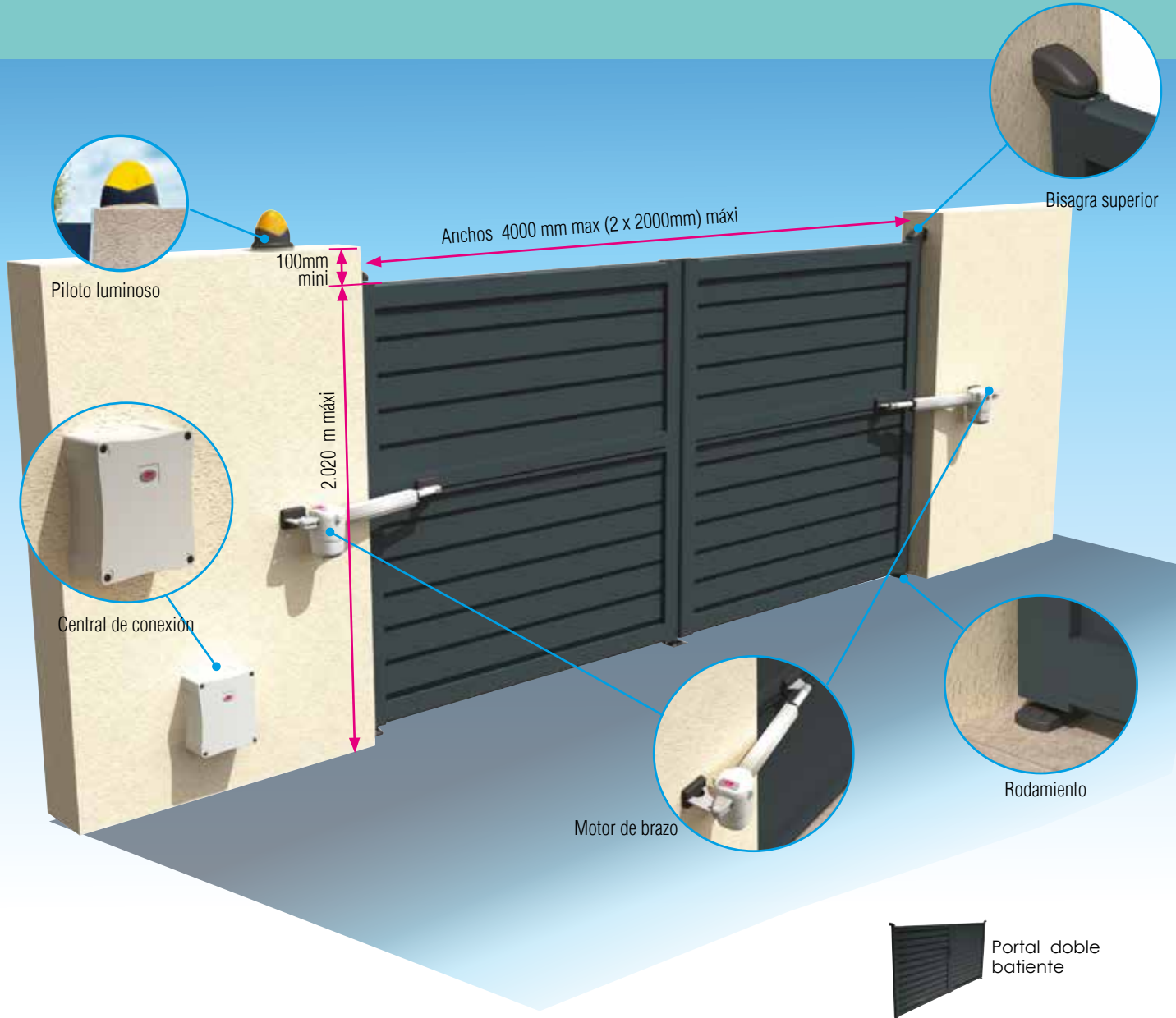

KIT PORTAL DOBLE BATIENTE | con paneles Lamas venecianas

DOUBLE SWING GATES / Brise view - PORTALE DOBLES BATIENTES / Kit portail double BATIENTES à panneaux semi-ajourée / Lamas venecianas - CANCELLO A DOPPIA ANTA / Con vista



Instalación en superficie



Instalación en tablero únicamente a medida



Portal en KIT para montar doble batiente – Tarifa sin IVA

Incluye : Kit WINGATE FIRST + Valor a medida : +20%T

Alto* \ Anchos entre pilares	3000	3250	3500	3750	4000
1571mm	3 991 €	4 018 €	4 058 €	4 237 €	4 418 €
1720mm	4 403 €	4 431 €	4 471 €	4 650 €	4 831 €
1870mm	4 547 €	4 585 €	4 624 €	4 812 €	5 002 €
2020mm	4 789 €	4 812 €	4 869 €	5 068 €	5 266 €



* Altura desde el suelo hasta encima del portal.

Opción: Kit WINGATE HOME : + 610.00 €

Información

Portal de aluminio double batiente con paneles tipo lamas venecianas, motorizado con elementos de seguridad. Instalación sencilla gracias a los bisagras y rodamientos.

Acabado

Acabado Ral. Estándar

- RAL 7016** Texturado
 - RAL 9010** Brillante
- Otro ral : +20%

Piezas y perfiles



PPC06



PPC02



PPC01



EBPPC02



EBPPC01



CL0702



KIT WINGATE FIRST
Motor con brazo 220 V
Ver página 36



PPC05



CHP23



CHP21



CHP22

KIT PORTAL DOBLE BATIENTE | con paneles Mixtos

DOUBLE SWING GATES / Kit portail double BATIENTES à panneaux mixte
/PORTÃO FOLHA DUPLA / Mixto - CANCELLO A DOPPIA ANTA / Misto

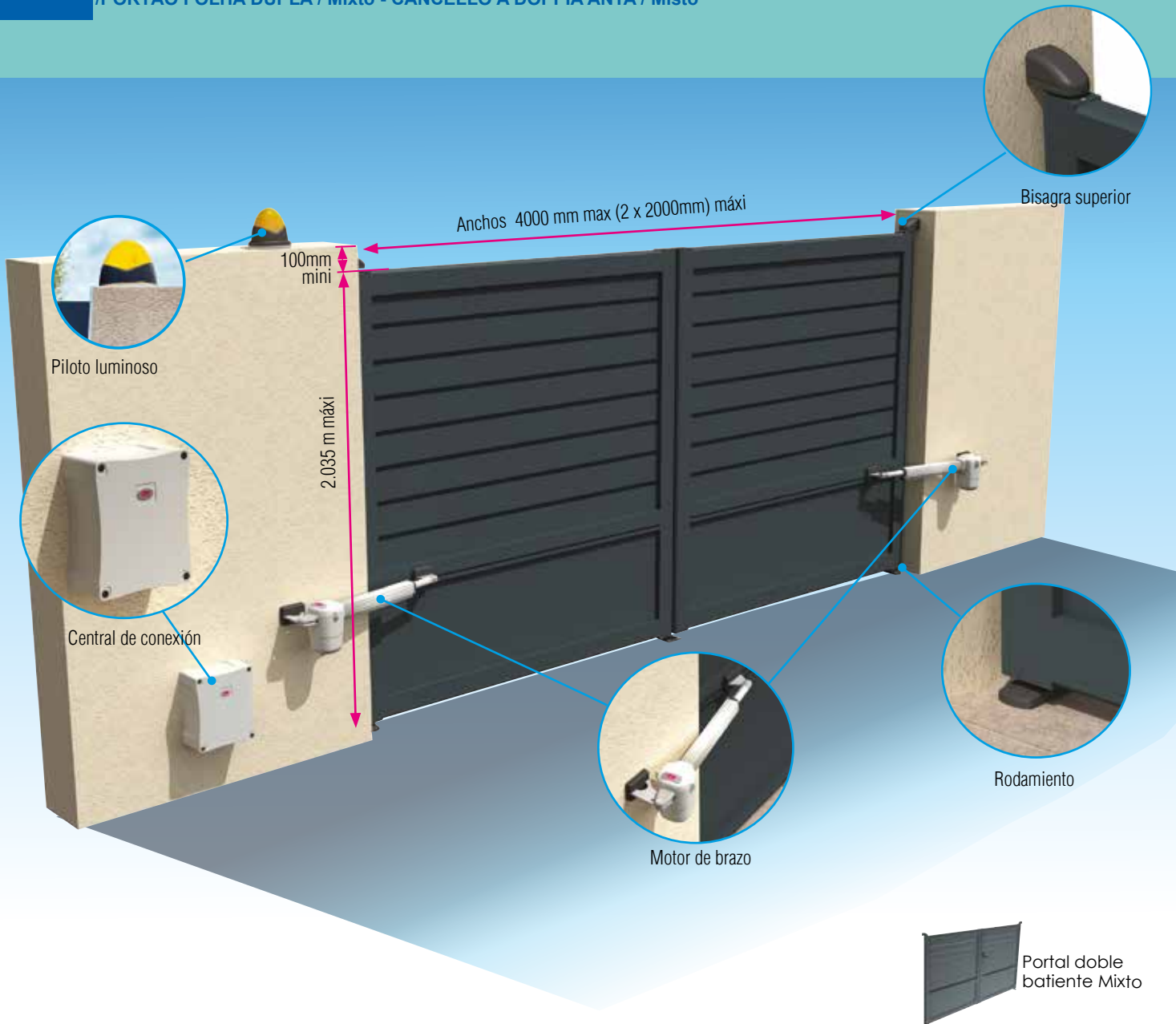

KIT PORTAL DOBLE BATIENTE | con paneles Mixtos

DOUBLE SWING GATES / Kit portail double BATIENTES à panneaux mixte
/PORTÃO FOLHA DUPLA / Mixto - CANCELLO A DOPPIA ANTA / Misto

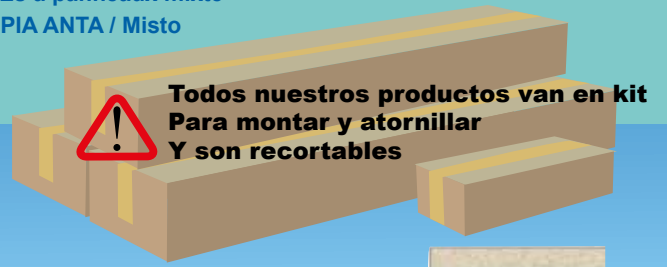

Instalación en superficie



Instalación en tablero únicamente a medida



Portal en KIT para montar doble batiente – Tarifa sin IVA

Incluye : Kit WINGATE FIRST + Valor a medida : +20%T

Alto* \ Anchos entre pilares	3000	3250	3500	3750	4000
1585mm	4 129 €	4 172 €	4 199 €	4 379 €	4 560 €
1735mm	4 414 €	4 457 €	4 484 €	4 664 €	4 844 €
1885mm	4 563 €	4 591 €	4 636 €	4 826 €	5 017 €
2035mm	4 798 €	4 837 €	4 881 €	5 079 €	5 279 €



* Altura desde el suelo hasta encima del portal. Opción: Kit WINGATE HOME : + 610.00 €

Información

Portal de aluminio doble batiente con paneles mixtos, motorizado, con medios de seguridad.

Acabado

Acabado Ral. Estándar

- RAL 7016 Texturado
 - RAL 9010 Brillante
- Otro ral : +20%

Piezas y perfiles



Kit PUERTAS PEATONALES | con paneles Ciegos

SMALL GATE / full - Kit Portillon Ciego

PEQUENO PORTÃO / completo - PICCOLO CANCELLO / completo

NEW
NUEVO
NOUVEAU
NOVO



Maneta con cerradura

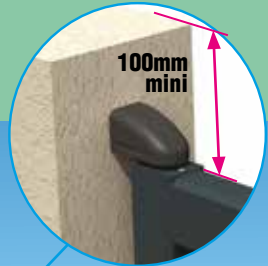

Bisagra superior

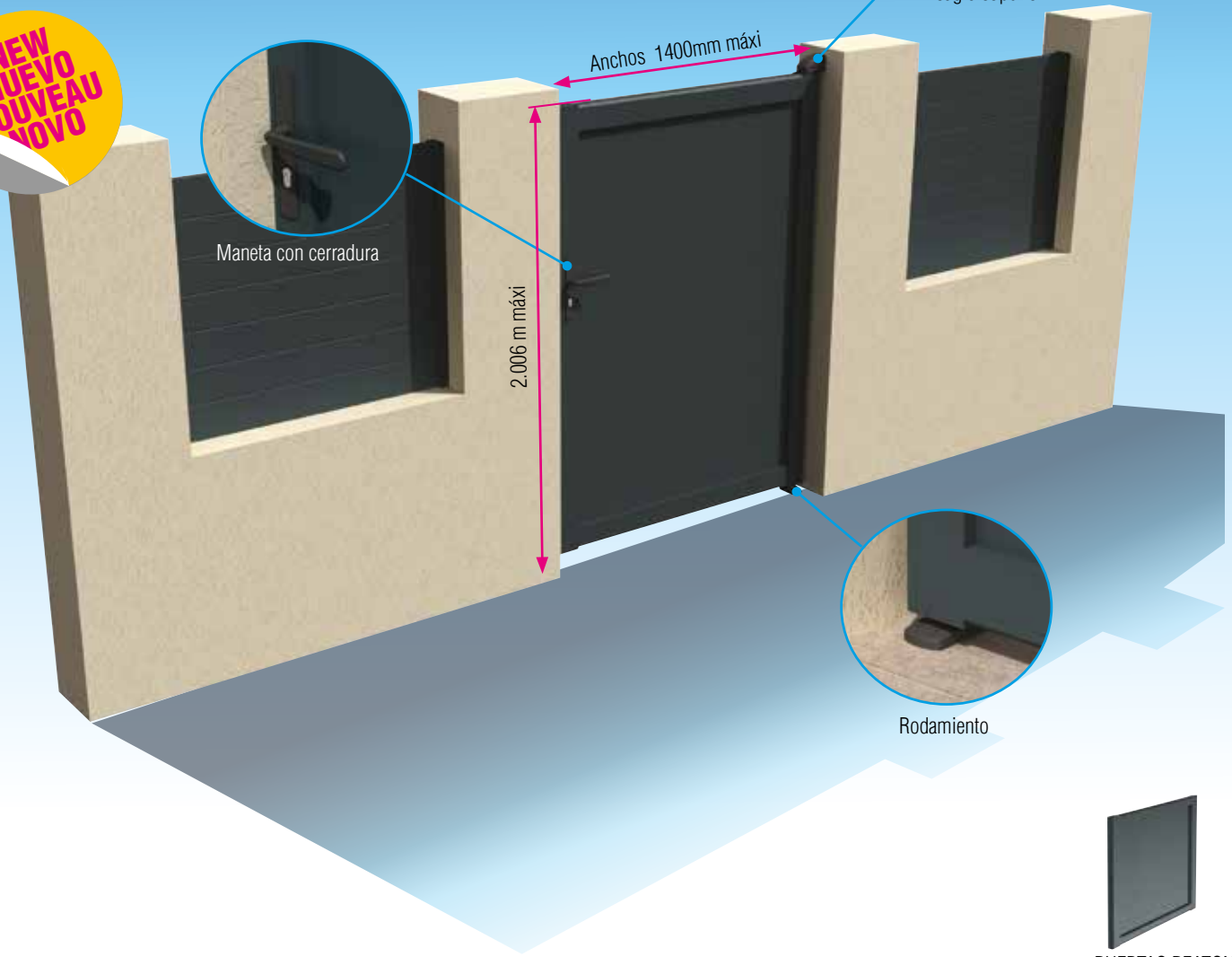

PUERTAS PEATONALES Ciego



Kit PUERTAS PEATONALES | con paneles Ciegos

SMALL GATE / full - Kit Portillon Ciego

PEQUENO PORTÃO / completo - PICCOLO CANCELLO / completo



Instalación en tablero



Portal en KIT para montar simple batiente – Tarifa sin IVA + Valor a medida : +20%T

Alto* \ Anchos entre pilares	800	900	1000	1100	1200	1300	1400
1555mm	1 119 €	1 199 €	1 322 €	1 301 €	1 510 €	1 473 €	1 535 €
1705mm	1 236 €	1 314 €	1 389 €	1 465 €	1 542 €	1 618 €	1 695 €
1856mm	1 288 €	1 365 €	1 441 €	1 518 €	1 594 €	1 671 €	1 746 €
2006mm	1 376 €	1 453 €	1 529 €	1 605 €	1 682 €	1 759 €	1 834 €

* Altura desde el suelo hasta encima del portal.



Información

Puertas peatonal con panel lleno.
Fijación con bisagras y maneta con cerradura.
Instalación fácil y rápida.

Acabado

Acabado Ral. Estándar



Piezas y perfiles



Kit PUERTAS PEATONALES | con paneles venecianos

SMALL GATE / Brise view- Portillons simple BATIENTE / Venecianos
PEQUENO PORTÃO / Lamas venecianas - PICCOLO CANCELLO / Con vista

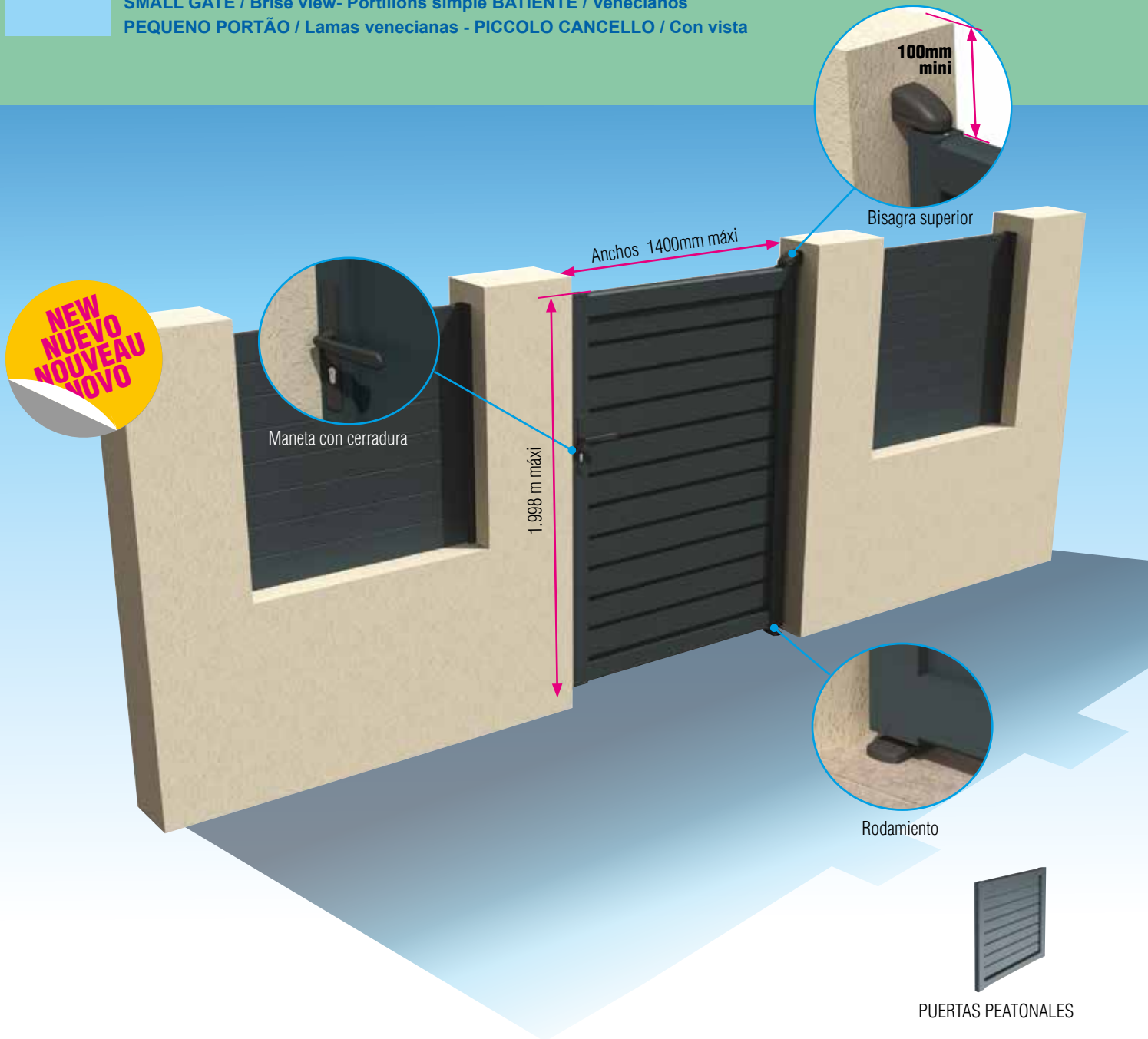

Kit PUERTAS PEATONALES | con paneles **venecianos**

SMALL GATE / Brise view- Portillons simple **BATIENTE** / Venecianos
 PEQUENO PORTÃO / Lamas venecianas - PICCOLO CANCELLO / Con vista



Instalación en tablero



Portal en KIT para montar simple batiente – Tarifa sin IVA + Valor a medida : +20%T

Alto* \ Anchos entre pilares	800	900	1000	1100	1200	1300	1400
1548mm	1 007 €	1 069 €	1 168 €	1 145 €	1 312 €	1 281 €	1 328 €
1698mm	1 172 €	1 242 €	1 314 €	1 384 €	1 454 €	1 525 €	1 595 €
1848mm	1 212 €	1 282 €	1 352 €	1 425 €	1 495 €	1 566 €	1 636 €
1998mm	1 294 €	1 364 €	1 434 €	1 505 €	1 575 €	1 646 €	1 717 €

* Altura desde el suelo hasta encima del portal.



Información

Puerta peatonal con paneles veneciano.
 Fijación con bisagras y maneta con cerradura.
 Instalación fácil y rápida.

Acabado

Acabado Ral. Estándar



Piezas y perfiles



Kit PUERTAS PEATONALES | con paneles Mixto

SMALL GATE / Brise Mixed - PORTILLON simple BATIENTE / Mixte
PEQUENO PORTÃO / Mixto - PICCOLO CANCELLO / Misto

**NEW
NUEVO
NOUVEAU
NOVO**

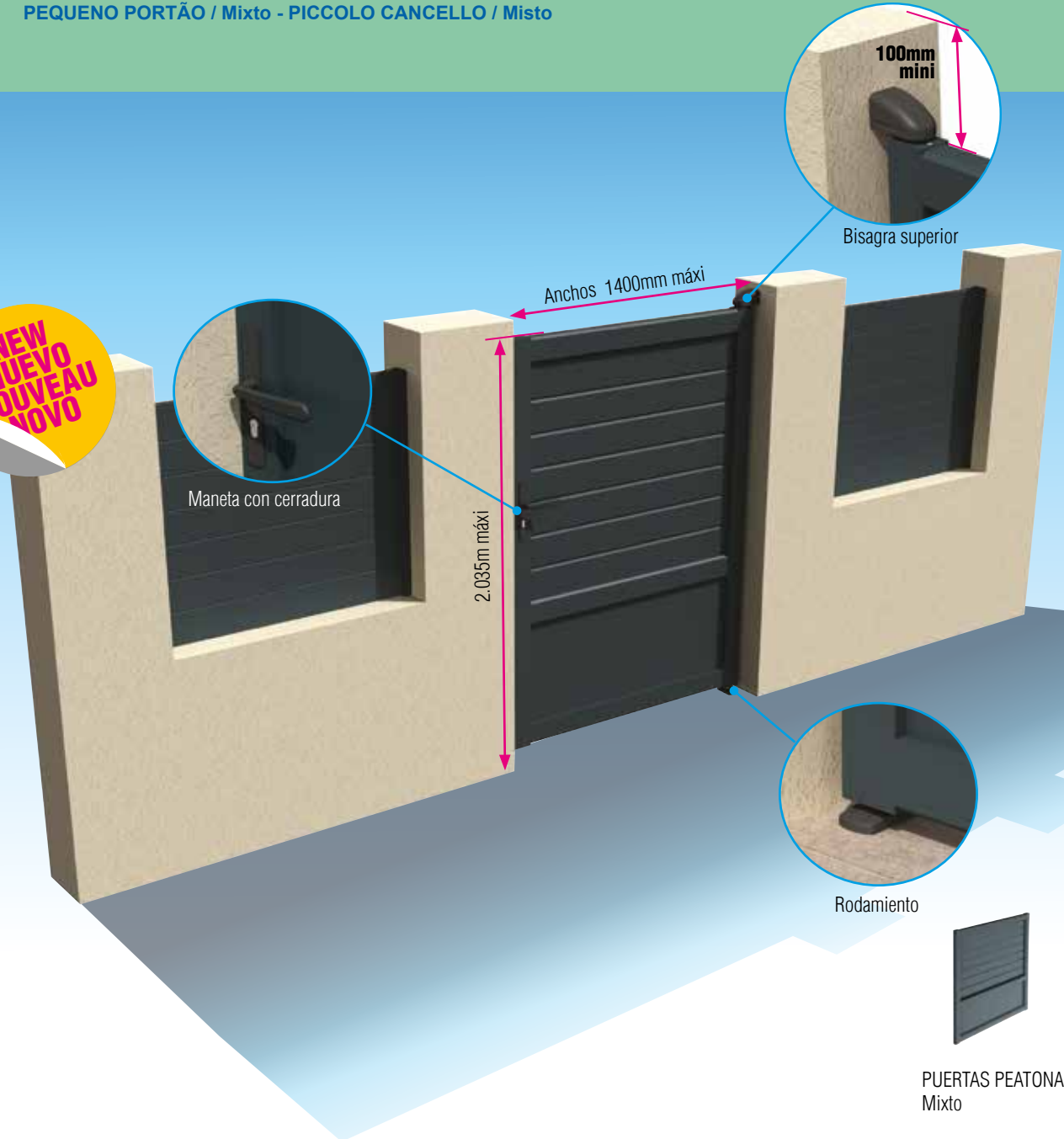

Kit PUERTAS PEATONALES | con paneles Mixto

SMALL GATE / Brise Mixed - PORTILLON simple BATIENTE / Mixte
PEQUENO PORTÃO / Mixto - PICCOLO CANCELLO / Misto



Instalación en tablero



Portal en KIT para montar simple batiente – Tarifa sin IVA + Valor a medida : +20%T

Alto* \ Anchos entre pilares	800	900	1000	1100	1200	1300	1400
1585mm	1 096 €	1 173 €	1 311 €	1 274 €	1 463 €	1 438 €	1 499 €
1735mm	1 216 €	1 285 €	1 355 €	1 425 €	1 494 €	1 563 €	1 633 €
1886mm	1 264 €	1 335 €	1 404 €	1 473 €	1 542 €	1 612 €	1 681 €
2035mm	1 345 €	1 414 €	1 484 €	1 553 €	1 623 €	1 693 €	1 762 €

* Altura desde el suelo hasta encima del portal.



Información

Puerta peatonal con con panel mixto.
Fijación con bisagras y maneta con cerradura.
Instalación fácil y rápida.

Acabado



Piezas y perfiles



CLOTURES - FENCING - VALLAS - REGINZIONE





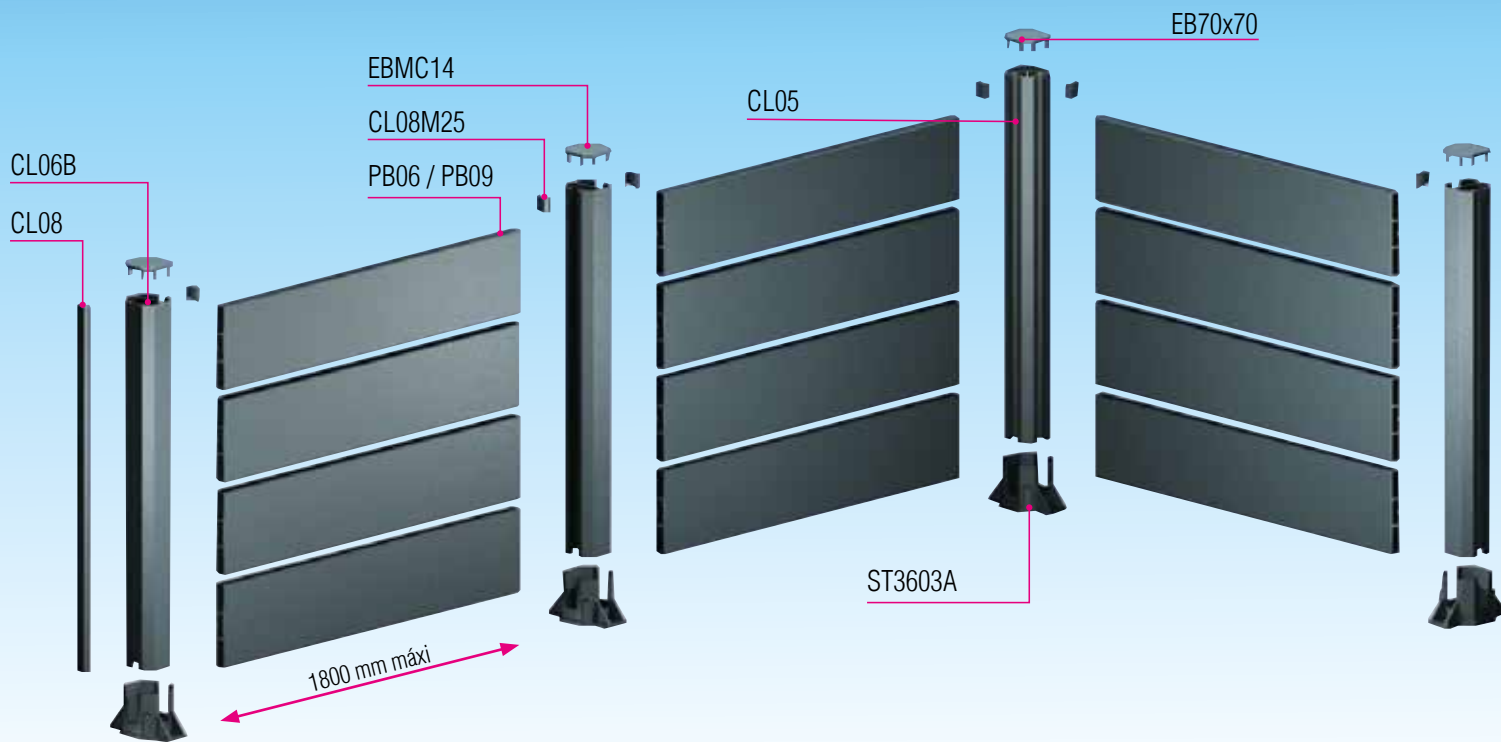

Información

Valla tradicional con paneles ciegos (totalmente ocultantes). Montaje simple gracias a los pies de fijación. Montaje de las lamas desde la parte superior. Altura máxima 1 715 mm

Acabado

Selección de colores Texturados :

+16% en estructura solo lacado blanco Ral 9010

● RAL 8019 ● RAL 8014 ● RAL 7022

● RAL 5014 ● RAL 3005 ● RAL 6021

● RAL 7011 ● RAL 9005 ● RAL 7016

● RAL 9006 ● RAL 1015 ● RAL 7035

+20% Otros Ral

Acabado Ral. Estándar



Piezas y perfiles

Colocación estándar



Colocación en fachada
Información p.32



Colocación entre paredes
Información p.32



Kit VALLA RANCH | Panel ocultante

RANCH FENCE - VALLA RANCH - RECINZIONE RANCH



Panel con lamas horizontales cerradas (sin visibilidad)

PB06

+ Valor a medida : +20%T

KIT RANCH SIN VISIBILIDAD LAMAS PB06 Precio sin I.V.A Entrega en Kit - Largo de la lama estandar 1800 mm

Esloza total en mm >	1911	3731	5551	7371	9191	11011	12831	14651	16471	18291
Nb. Módulo >	1	2	3	4	5	6	7	8	9	10
Nb. de pies >	2	3	4	5	6	7	8	9	10	11
Alto Nb. lamas										
215 mm 1	223 €	400 €	594 €	777 €	960 €	1 143 €	1 326 €	1 509 €	1 692 €	1 875 €
365 mm 2	305 €	557 €	841 €	1 104 €	1 365 €	1 626 €	1 889 €	2 150 €	2 412 €	2 674 €
515 mm 3	389 €	713 €	1 087 €	1 428 €	1 768 €	2 109 €	2 450 €	2 790 €	3 131 €	3 471 €
665 mm 4	472 €	870 €	1 334 €	1 753 €	2 172 €	2 591 €	3 011 €	3 430 €	3 849 €	4 269 €
815 mm 5	555 €	1 026 €	1 580 €	2 077 €	2 575 €	3 074 €	3 572 €	4 069 €	4 568 €	5 066 €
965 mm 6	637 €	1 184 €	1 826 €	2 402 €	2 979 €	3 556 €	4 133 €	4 710 €	5 286 €	5 863 €
1115 mm 7	721 €	1 341 €	2 072 €	2 728 €	3 382 €	4 038 €	4 693 €	5 349 €	6 005 €	6 660 €
1265 mm 8	825 €	1 528 €	2 367 €	3 115 €	3 861 €	4 607 €	5 355 €	6 101 €	6 848 €	7 595 €
1415 mm 9	907 €	1 685 €	2 614 €	3 439 €	4 266 €	5 090 €	5 916 €	6 741 €	7 566 €	8 392 €
1565 mm 10	990 €	1 841 €	2 860 €	3 764 €	4 668 €	5 572 €	6 477 €	7 381 €	8 285 €	9 189 €
1715 mm 11	1 074 €	1 999 €	3 106 €	4 089 €	5 072 €	6 055 €	7 038 €	8 021 €	9 004 €	9 986 €

Para atornillar o sellar 300 mm

Para sellar 500 mm

Colocación en fachada +15%



PB09

KIT RANCH SIN VISIBILIDAD LAMAS PB09 Precio sin I.V.A Entrega en Kit - Largo de la lama estandar 1800 mm

Esloza total en mm >	1911	3731	5551	7371	9191	11011	12831	14651	16471	18291
Nb. Módulo >	1	2	3	4	5	6	7	8	9	10
Nb. de pies >	2	3	4	5	6	7	8	9	10	11
Alto Nb. lamas										
165 mm 1	189 €	329 €	478 €	625 €	771 €	916 €	1 062 €	1 207 €	1 354 €	1 499 €
265 mm 2	237 €	424 €	624 €	815 €	1 007 €	1 198 €	1 390 €	1 581 €	1 773 €	1 965 €
365 mm 3	286 €	516 €	765 €	1 002 €	1 239 €	1 475 €	1 712 €	1 949 €	2 185 €	2 422 €
465 mm 4	334 €	606 €	907 €	1 190 €	1 471 €	1 753 €	2 034 €	2 316 €	2 599 €	2 880 €
565 mm 5	381 €	697 €	1 050 €	1 376 €	1 703 €	2 030 €	2 357 €	2 685 €	3 011 €	3 338 €
665 mm 6	431 €	787 €	1 192 €	1 563 €	1 936 €	2 308 €	2 680 €	3 052 €	3 424 €	3 796 €
765 mm 7	478 €	879 €	1 334 €	1 751 €	2 168 €	2 585 €	3 002 €	3 420 €	3 837 €	4 255 €
865 mm 8	527 €	969 €	1 475 €	1 938 €	2 400 €	2 862 €	3 325 €	3 787 €	4 250 €	4 712 €
965 mm 9	576 €	1 060 €	1 617 €	2 125 €	2 633 €	3 140 €	3 647 €	4 155 €	4 662 €	5 170 €
1065 mm 10	624 €	1 150 €	1 760 €	2 312 €	2 864 €	3 418 €	3 970 €	4 522 €	5 075 €	5 628 €
1165 mm 11	669 €	1 236 €	1 899 €	2 496 €	3 094 €	3 690 €	4 288 €	4 885 €	5 482 €	6 079 €

Para atornillar o sellar 300 mm

Para sellar 500 mm



ST36 para sellar



Todos nuestros productos van en kit
Para montar y atornillar
Y son recortables

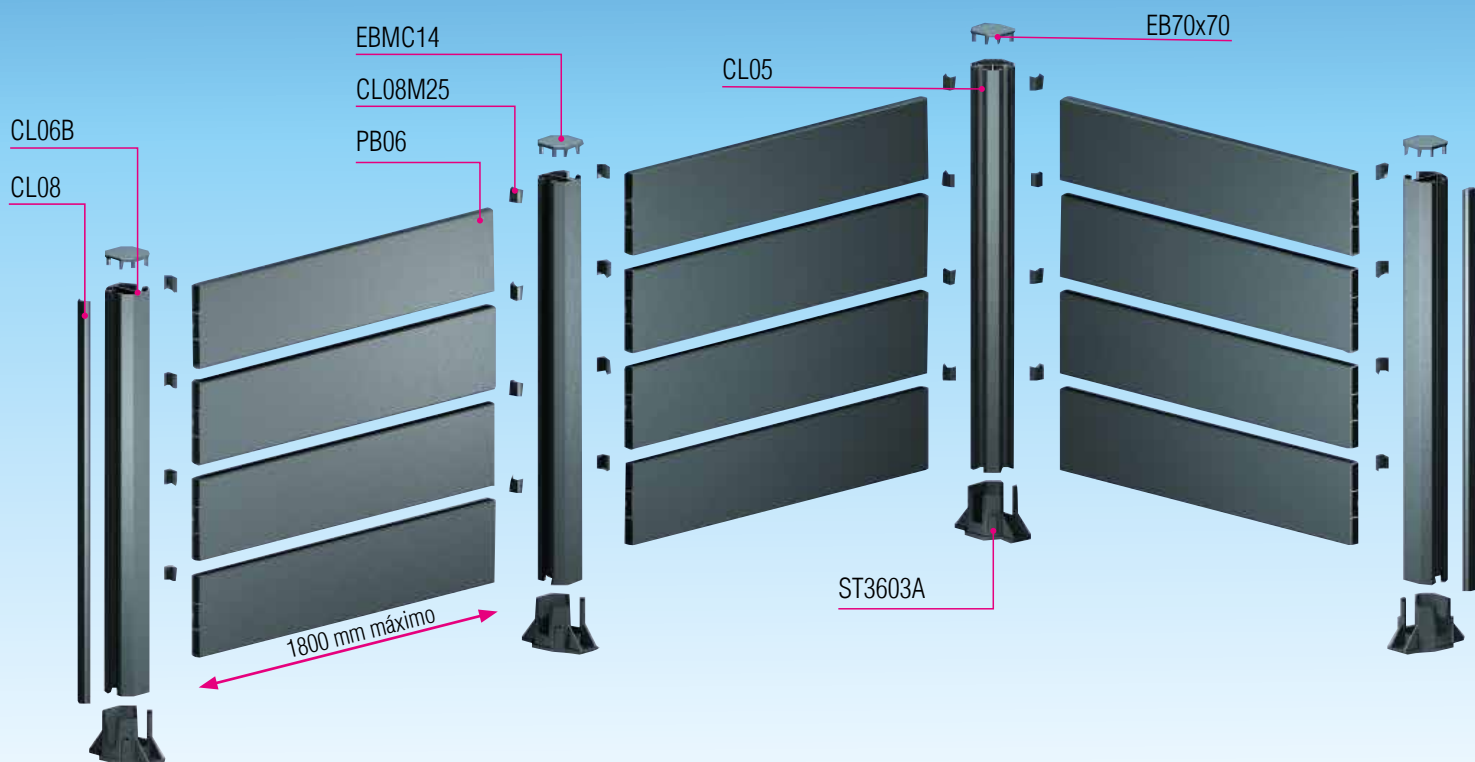

Información Valla tradicional con paneles espaciados. Montaje simple gracias a los pies de fijación. Ensamblaje de las lamas por arriba. Alto máximale 1 790 mm

Acabado

Selección de colores Texturados :
 +16% en estructura solo lacado blanco Ral 9010

+20% Otros Ral

Acabado Ral. Estándar

Texturado	Brillante

Piezas y perfiles

Colocación estándar



Colocación en fachada
 Información p.32



Colocación entre paredes
 Información p.32



Kit VALLAS RANCH | Panel abierto

RANCH FENCE - VALLA VenecianosE - RECINZIONE RANCH



Panel con lamas horizontales abierto

PB06

+ Valor a medida : +20%T

KIT RANCH ABIERTO LAMAS PB06 Precio sin I.V.A Entrega en Kit - Largo de la lama estandar 1800 mm

Esloza total en mm >	1911	3731	5551	7371	9191	11011	12831	14651	16471	18291
Nb. Módulo >	1	2	3	4	5	6	7	8	9	10
Nb. de pies >	2	3	4	5	6	7	8	9	10	11
Alto Nb. lamas										
215 mm 1	223 €	395 €	592 €	774 €	957 €	1 139 €	1 322 €	1 504 €	1 687 €	1 869 €
390 mm 2	312 €	567 €	856 €	1 122 €	1 388 €	1 655 €	1 921 €	2 187 €	2 453 €	2 720 €
565 mm 3	400 €	733 €	1 117 €	1 466 €	1 816 €	2 165 €	2 515 €	2 864 €	3 214 €	3 563 €
740 mm 4	488 €	900 €	1 378 €	1 810 €	2 244 €	2 676 €	3 109 €	3 541 €	3 975 €	4 407 €
915 mm 5	577 €	1 066 €	1 639 €	2 155 €	2 671 €	3 187 €	3 702 €	4 218 €	4 734 €	5 250 €
1090 mm 6	666 €	1 233 €	1 901 €	2 499 €	3 098 €	3 698 €	4 296 €	4 896 €	5 495 €	6 094 €
1265 mm 7	776 €	1 431 €	2 212 €	2 906 €	3 601 €	4 296 €	4 991 €	5 686 €	6 380 €	7 075 €
1440 mm 8	864 €	1 598 €	2 473 €	3 250 €	4 029 €	4 807 €	5 584 €	6 363 €	7 141 €	7 918 €
1615 mm 9	954 €	1 764 €	2 734 €	3 595 €	4 456 €	5 317 €	6 178 €	7 039 €	7 902 €	8 763 €
1790 mm 10	1 042 €	1 930 €	2 995 €	3 939 €	4 884 €	5 828 €	6 773 €	7 718 €	8 661 €	9 606 €

Para atornillar o sellar 300 mm

Para sellar 500 mm

Colocación en fachada +15%

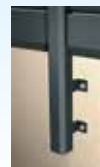

PB09

KIT RANCH ABIERTO LAMAS PB09 Precio sin I.V.A Entrega en Kit - Largo de la lama estandar 1800 mm

Esloza total en mm >	1911	3731	5551	7371	9191	11011	12831	14651	16471	18291
Nb. Módulo >	1	2	3	4	5	6	7	8	9	10
Nb. de pies >	2	3	4	5	6	7	8	9	10	11
Alto Nb. lamas										
165 mm 1	189 €	334 €	482 €	627 €	774 €	921 €	1 067 €	1 213 €	1 359 €	1 506 €
290 mm 2	243 €	434 €	628 €	821 €	1 014 €	1 207 €	1 400 €	1 593 €	1 786 €	1 979 €
415 mm 3	297 €	535 €	776 €	1 015 €	1 255 €	1 494 €	1 733 €	1 972 €	2 212 €	2 451 €
540 mm 4	351 €	636 €	924 €	1 209 €	1 496 €	1 782 €	2 067 €	2 353 €	2 638 €	2 924 €
665 mm 5	405 €	736 €	1 072 €	1 403 €	1 736 €	2 068 €	2 400 €	2 733 €	3 065 €	3 397 €
790 mm 6	459 €	837 €	1 219 €	1 599 €	1 977 €	2 356 €	2 734 €	3 113 €	3 492 €	3 871 €
915 mm 7	514 €	938 €	1 367 €	1 793 €	2 217 €	2 643 €	3 068 €	3 493 €	3 918 €	4 343 €
1040 mm 8	458 €	1 039 €	1 515 €	1 987 €	2 459 €	2 929 €	3 401 €	3 873 €	4 345 €	4 816 €
1165 mm 9	622 €	1 139 €	1 663 €	2 181 €	2 699 €	3 217 €	3 734 €	4 252 €	4 771 €	5 289 €
1290 mm 10	697 €	1 271 €	1 860 €	2 438 €	3 014 €	3 591 €	4 169 €	4 745 €	5 322 €	5 899 €
1415 mm 11	751 €	1 372 €	2 008 €	2 632 €	3 255 €	3 879 €	4 503 €	5 126 €	5 750 €	6 372 €
1540 mm 12	805 €	1 472 €	2 155 €	2 826 €	3 496 €	4 165 €	4 836 €	5 506 €	6 175 €	6 845 €
1665 mm 13	859 €	1 572 €	2 303 €	3 020 €	3 736 €	4 453 €	5 169 €	5 885 €	6 602 €	7 318 €
1790 mm 14	913 €	1 674 €	2 451 €	3 214 €	3 977 €	4 740 €	5 503 €	6 266 €	7 028 €	7 791 €

Para atornillar o sellar 300 mm

Para sellar 500 mm



ST36 para sellar



Todos nuestros productos van en kit
Para montar y atornillar
Y son recortables

Kit Ocultante | Lamas espaciadas sin visibilidad

PRIVACY SLAT FENCING - Venecianos - VISTA BREZZA

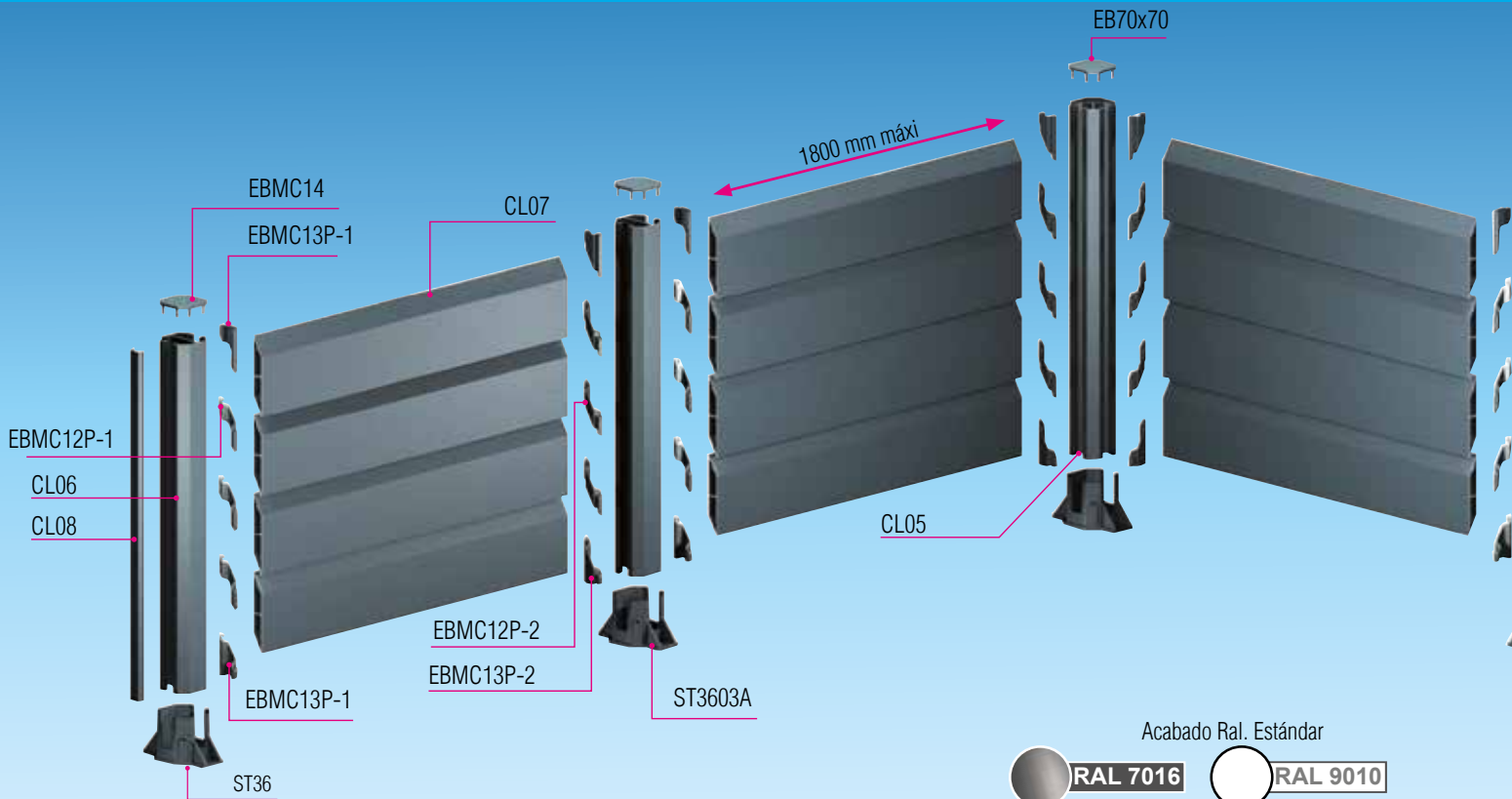

Información

Valla tradicional con paneles ocultante. Montaje simple gracias a los pies de fijación. Ensamblaje de las lamas por arriba. Alto máxime 2 109 mm

Acabado

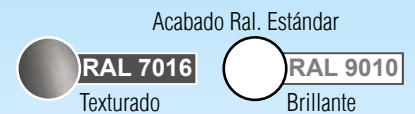

Selección de colores Texturados :

+16% en estructura solo lacado blanco Ral 9010



+20% Otros Ral

Piezas y perfiles

Colocación estándar

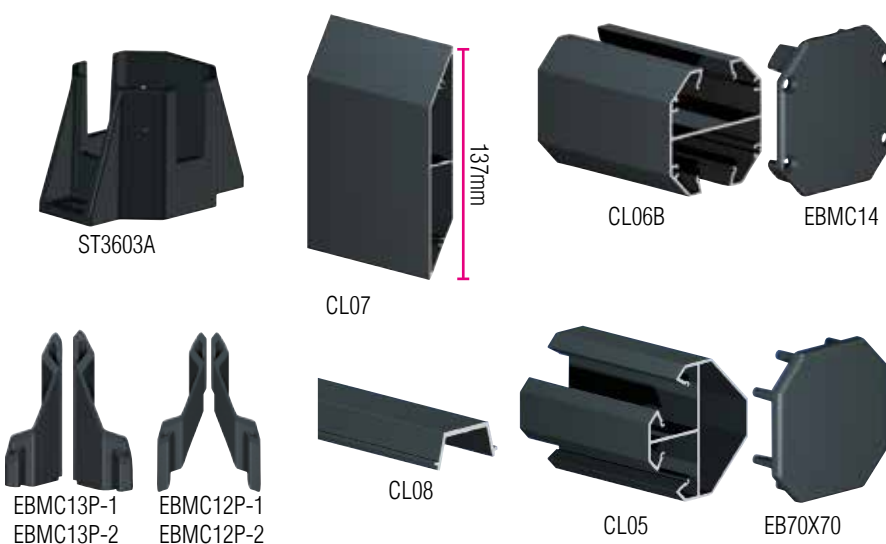

Colocación en fachada
Información p.32



Colocación entre paredes
Información p.32



Kit Ocultante | Lamas espaciadas sin visibilidad

PRIVACY SLAT FENCING - Venecianos - VISTA BREZZA



Paneles con lamas horizontales ocultantes, espaciadas sin visibilidad

CL07

+ Valor a medida : +20%T

KIT Lamas venecianas LAMAS CL07 Precio sin I.V.A Entrega en Kit- Largo de la lama estandard 1800 mm

Esloza total en mm >	1911	3731	5551	7371	9191	11011	12831	14651	16471	18291
Nb. Módulo >	1	2	3	4	5	6	7	8	9	10
Nb. de pies >	2	3	4	5	6	7	8	9	10	11
Alto Nb. lamas										
206 mm 1	203 €	361 €	533 €	695 €	857 €	1 019 €	1 181 €	1 343 €	1 505 €	1 667 €
342 mm 2	266 €	478 €	717 €	937 €	1 159 €	1 379 €	1 600 €	1 821 €	2 042 €	2 262 €
478 mm 3	330 €	596 €	902 €	1 181 €	1 461 €	1 740 €	2 020 €	2 299 €	2 579 €	2 859 €
614 mm 4	392 €	714 €	1 087 €	1 424 €	1 763 €	2 101 €	2 439 €	2 777 €	3 116 €	3 454 €
750 mm 5	455 €	833 €	1 271 €	1 668 €	2 065 €	2 462 €	2 859 €	3 256 €	3 653 €	4 049 €
886 mm 6	519 €	951 €	1 456 €	1 912 €	2 367 €	2 822 €	3 278 €	3 733 €	4 188 €	4 644 €
1022 mm 7	582 €	1 069 €	1 641 €	2 155 €	2 669 €	3 183 €	3 698 €	4 212 €	4 725 €	5 239 €
1157 mm 8	646 €	1 187 €	1 826 €	2 399 €	2 971 €	3 543 €	4 117 €	4 689 €	5 262 €	5 834 €
1293 mm 9	730 €	1 337 €	2 061 €	2 704 €	3 348 €	3 992 €	4 636 €	5 280 €	5 924 €	6 568 €
1429 mm 10	793 €	1 455 €	2 246 €	2 948 €	3 650 €	4 353 €	5 056 €	5 758 €	6 461 €	7 163 €
1565 mm 11	856 €	1 573 €	2 430 €	3 191 €	3 952 €	4 713 €	5 475 €	6 236 €	6 996 €	7 758 €
1701 mm 12	919 €	1 691 €	2 615 €	3 435 €	4 255 €	5 075 €	5 894 €	6 714 €	7 533 €	8 354 €
1837 mm 13	982 €	1 809 €	2 800 €	3 678 €	4 557 €	5 435 €	6 314 €	7 192 €	8 070 €	8 949 €
1973 mm 14	1 045 €	1 927 €	2 984 €	3 922 €	4 859 €	5 796 €	6 733 €	7 670 €	8 607 €	9 544 €
2109 mm 15	1 109 €	2 046 €	3 170 €	4 165 €	5 161 €	6 156 €	7 152 €	8 149 €	9 144 €	10 140 €

Para atornillar o sellar 300 mm

Para sellar 500 mm

Colocación en fachada +15%



ST36 para sellar



Todos nuestros productos van en kit
Para montar y atornillar
Y son recortables

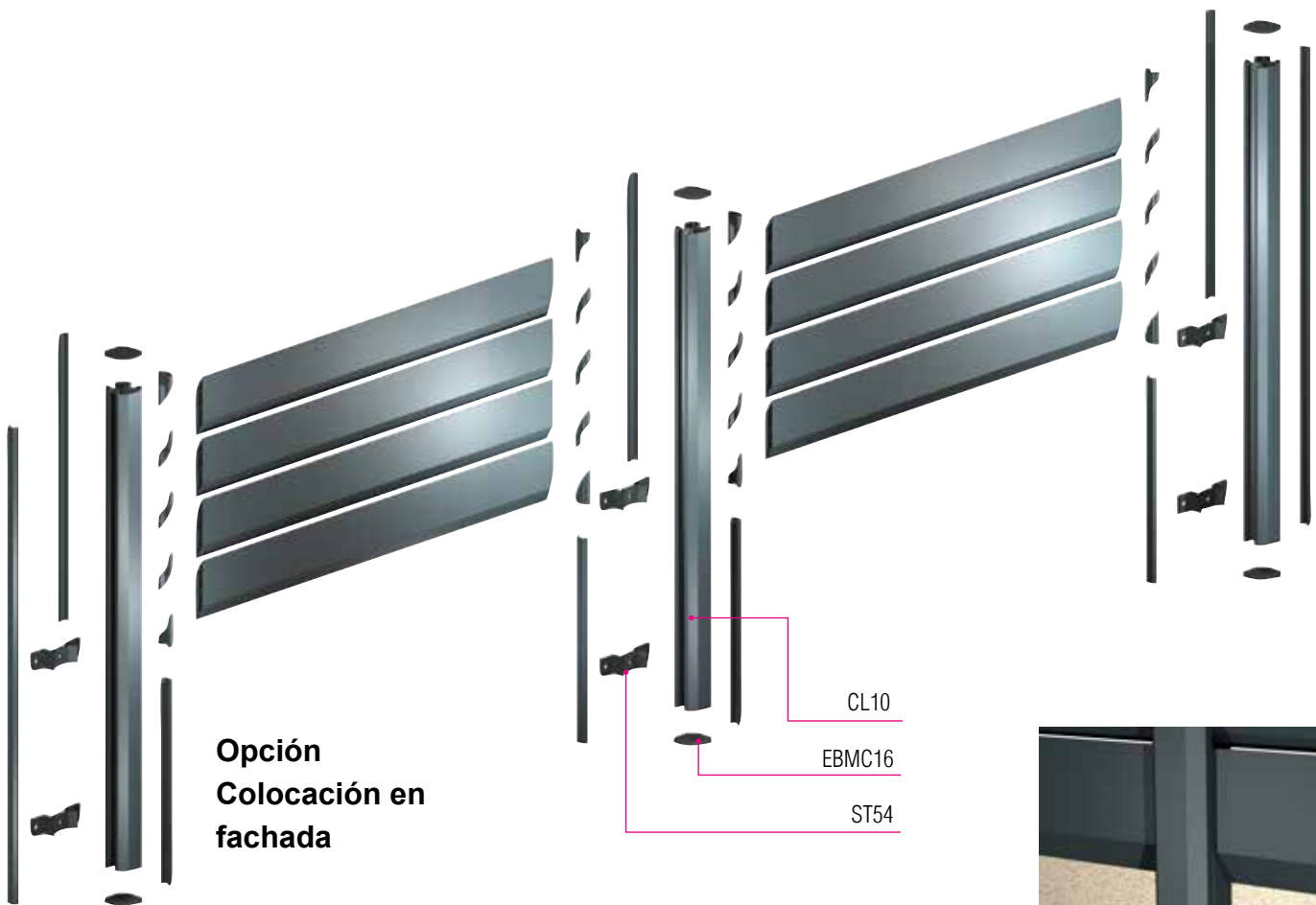
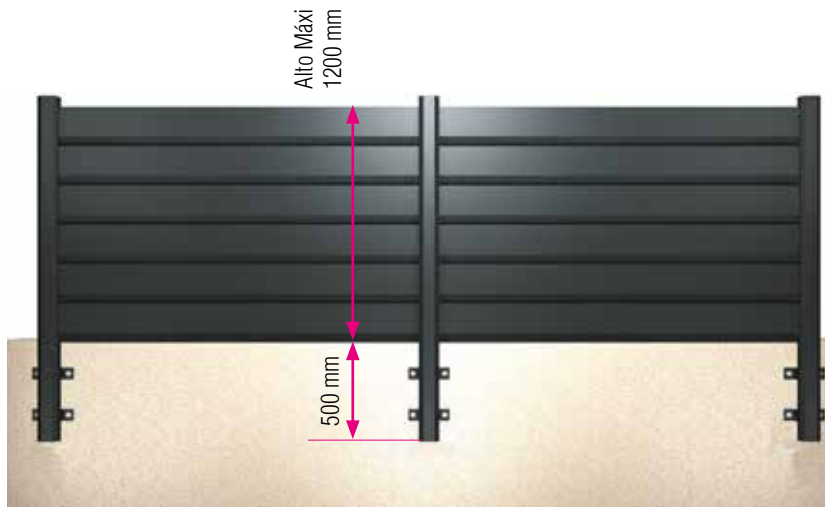

Opción Colocación en fachada

CL10

EBMC16

ST54

Acabado Ral. Estándar















RAL 7016
Texturado



RAL 9010
Brillante

Selección de colores Texturados :

+16% en estructura solo lacado blanco Ral 9010

-  RAL 8019
-  RAL 8014
-  RAL 6021
-  RAL 5014
-  RAL 3005
-  RAL 7016
-  RAL 7011
-  RAL 9005
-  RAL 7035
-  RAL 9006
-  RAL 1015
-  RAL 7022

+20% Otros Ral



VALLAS RANCH

Panneau Ciego / Espaciado

UNITARIO

ACONDICIONADO

Referencia	Bruto	Lacado RAL Estándar	Bruto	Lacado RAL Estándar	Unidad	Cond	Lg	Dispo
EB70X70	11,43 €	11,63 €	9,15 €	9,30 €	U		50	
ST3603A	20,39 €	24,54 €	16,22 €	19,64 €	U		20	
ST36	20,39 €	24,54 €	16,22 €	19,64 €	U		20	
EBMC14	13,86 €	14,09 €	11,09 €	11,28 €	U		100	
EBMC15	10,33 €	11,53 €	8,26 €	9,21 €	U		100	
EBMC1502	11,47 €	12,69 €	9,18 €	10,15 €	U		100	
EBMC16	19,99 €	23,40 €	15,99 €	18,73 €	U		100	
CL08	7,24 €	7,68 €	5,79 €	6,13 €	MI		35	6,00
CL08M25	1,50 €	1,69 €	1,17 €	1,31 €	U		200	
CL08M29	1,50 €	1,69 €	1,17 €	1,31 €	U		200	
CL06B	63,43 €	65,29 €	50,74 €	52,23 €	MI		16	6,00
PB06	47,48 €	48,15 €	37,98 €	38,50 €	MI		9	5,60
PB09	26,28 €	27,06 €	21,02 €	21,66 €	MI		16	6,00
CL05	52,14 €	53,88 €	41,71 €	43,11 €	MI		16	6,00
CL09	36,28 €	37,19 €	29,02 €	29,76 €	MI		32	6,00
CL10	63,75 €	65,98 €	50,99 €	52,80 €	MI		16	6,00
ST54	12,57 €	13,76 €	9,94 €	11,00 €	U		50	

Lamas venecianas

Lamas caladas sin visual

EB70X70	11,43 €	11,63 €	9,15 €	9,30 €	U		50	
ST3603A	20,39 €	24,54 €	16,22 €	19,64 €	U		20	
EBMC14	13,86 €	14,09 €	11,09 €	11,28 €	U		100	
EBMC12P	1,03 €	- €	0,81 €	- €	U		100	
EBMC13P	1,12 €	- €	0,85 €	- €	U		100	
EBMC15	10,33 €	11,53 €	8,26 €	9,21 €	U		100	
EBMC1502	11,47 €	12,69 €	9,18 €	10,15 €	U		100	
EBMC16	19,99 €	23,40 €	15,99 €	18,73 €	U		100	
CL05	52,14 €	53,88 €	41,71 €	43,11 €	MI		16	6,00
CL08	7,24 €	7,68 €	5,79 €	6,13 €	MI		35	6,00
CL07	32,63 €	33,73 €	26,10 €	26,98 €	MI		24	5,60
CL06B	30,29 €	31,51 €	27,26 €	28,36 €	MI		16	6,00
CL09	36,28 €	37,19 €	29,02 €	29,76 €	MI		16	6,00
CL10	63,75 €	65,98 €	50,99 €	52,80 €	MI		16	6,00
ST54	12,57 €	13,76 €	9,94 €	11,00 €	U		50	



INFORMACIÓN TÉCNICAS Y MONTAJES

INSTALACIÓN EN FACHADA

La opción de instalación en fachada (a la Inglesa) gracias al perfil **CL10** permite fijarse directamente en la pared, usando 2 soportes por poste y un tapón alto y bajo van previstos.



INSTALACIÓN DE 3 VALLAS CON UN POSTE DE ESQUINA

El perfil **CL10** también permite que la instalación en **T (3 salidas)** para realizar 3 lados

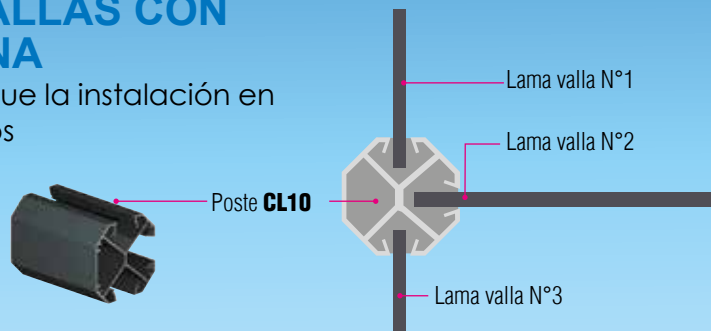

INSTALACIÓN CON PILAR DE HORMIGÓN

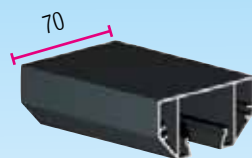

Soporte de montaje para pilar **CL09**

Otra opción de montaje con el pilar **CL09** en lugar de los poste. Se pueden jejar las lamas en un pilar de cemento existente (cerca de cemento)

Paneles ciegos ranch **PB06** (150)

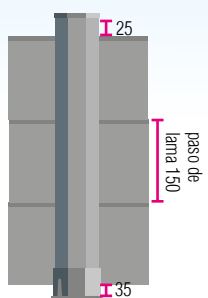

Nbr. de Lames	Alto H.T
3	515
4	665
5	815
6	965
7	1115
8	1265
9	1415
10	1565
11	1715

ENSAMBLADO DE LAS LAMAS

Paneles espaciados Ranch **PB06** (150)

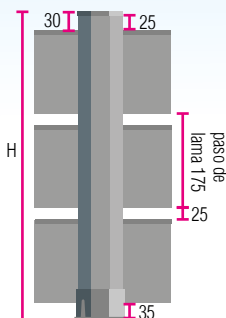

Nbr. de Lamas	Alto H.T
3	565
4	740
5	915
6	1090
7	1265
8	1440
9	1615
10	1790

Paneles espaciados Ranch **PB09** (100)

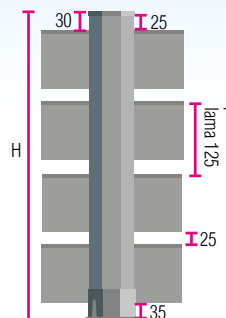

Nbr. de Lamas	Alto H.T	CL06B ou CL05
4	540	535
5	665	660
6	790	785
7	915	910
8	1040	1035
9	1165	1160
10	1290	1285
11	1415	1410
12	1540	1535
13	1665	1660
14	1790	1785

Paneles ciegos Ranch **PB09** (100)

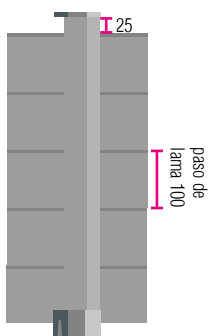

Nbr. de Lamas	Alto H.T	CL06B ou CL05
5	565	560
6	665	660
7	765	760
8	865	860
9	965	960
10	1065	1060
11	1165	1160

Paneles venecianos **CL07** (136)

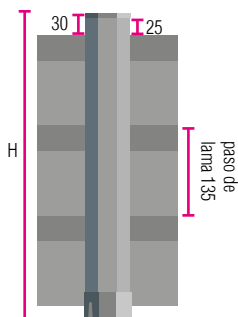

Nbr. de Lamas	Alto H.T	CL06B ou CL05
3	478	473
4	614	609
5	750	745
6	886	881
7	1022	1017
8	1157	1152
9	1293	1288
10	1429	1424
11	1565	1560
12	1701	1696
13	1837	1832

ST3603A (pie) soporte de fijación para poste de cerca

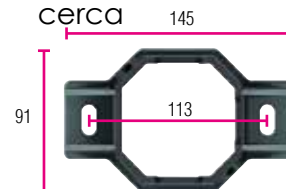



POSE EN APPLIQUE

L'option pose en applique (à l'anglaise) à l'aide du profilé **CL10** permet de fixer directement sur une clôture en dur, à l'aide de 2 supports par poteau, des bouchons haut et bas sont prévus.



POSE DE 3 CLOTURES AVEC UN SEUL POTEAU D'ANGLE

Le profilé **CL10** permet également la pose en **T** (3 départs) pour répartir sur 3 côtés.

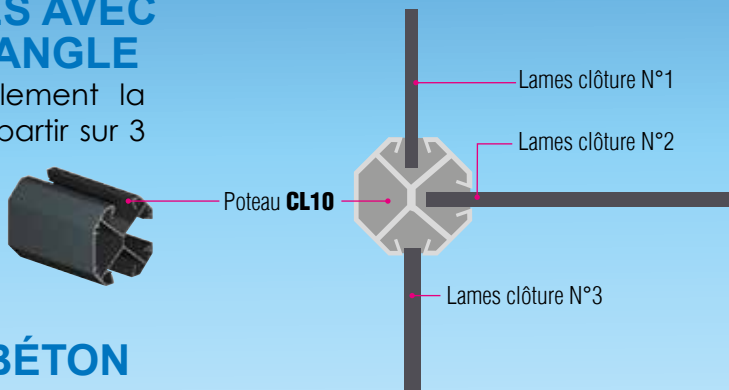

POSE AVEC PILIER BÉTON

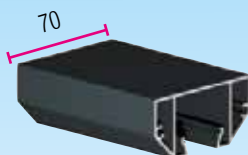

Support de fixation pour pilier **CL09**

Autre montage possible, avec le profilé **CL09** à la place des poteaux, il est possible de fixer les lames sur un pilier béton existant (clôture en dur)

Assemblage Ranch tablier plein **PB06** (150)

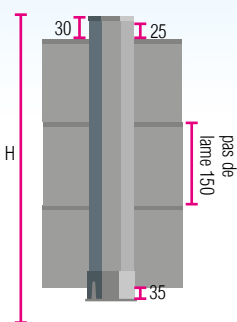

Nbr. de Lames	Hauteur H.T
3	515
4	665
5	815
6	965
7	1115
8	1265
9	1415
10	1565
11	1715

Assemblage Ranch tablier ajouré **PB06** (150)

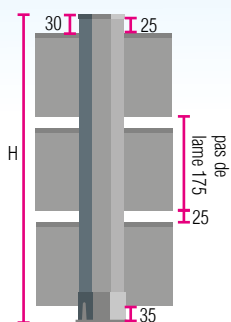

Nbr. de Lames	Hauteur H.T
3	565
4	740
5	915
6	1090
7	1265
8	1440
9	1615
10	1790

Assemblage Ranch tablier ajouré **PB09** (100)

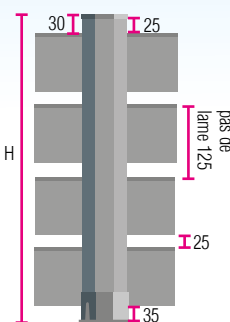

Nbr. de Lames	Hauteur H.T	CL06B ou CL05
4	540	535
5	665	660
6	790	785
7	915	910
8	1040	1035
9	1165	1160
10	1290	1285
11	1415	1410
12	1540	1535
13	1665	1660
14	1790	1785

Assemblage Ranch tablier plein **PB09** (100)

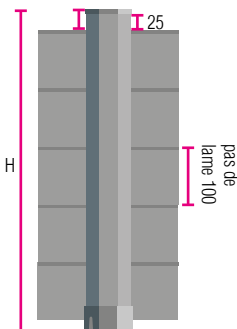

Nbr. de Lames	Hauteur H.T	CL06B ou CL05
5	565	560
6	665	660
7	765	760
8	865	860
9	965	960
10	1065	1060
11	1165	1160

Assemblage Brise vue **CL07** (136)

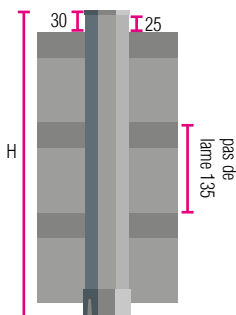

Nbr. de Lames	Hauteur H.T	CL06B ou CL05
3	478	473
4	614	609
5	750	745
6	886	881
7	1022	1017
8	1157	1152
9	1293	1288
10	1429	1424
11	1565	1560
12	1701	1696
13	1837	1832

ST3603A (pied) support de fixation pour poteau de clôture

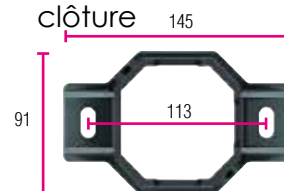



INSTALLAZIONE DISTANZIATA

L'opzione di installazione distanziata (all'inglese) utilizzando il profilo **CL10** permette di collegarsi direttamente ad una recinzione rigida, usando 2 supporti per ogni montante, sono forniti con tappi superiore e inferiore.



INSTALLAZIONE DI 3 RECINZIONI CON UN SOLO PALO D'ANGOLO

Il profilo **CL10** permette anche l'installazione a **T** (3 uscite) per ripartire su tre lati.

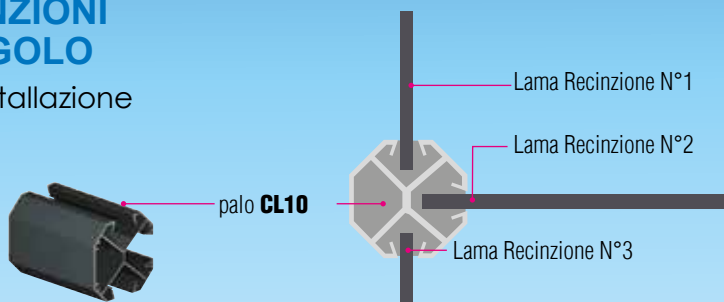

INSTALLAZIONE CON STRUTTURA IN CALCESTRUZZO

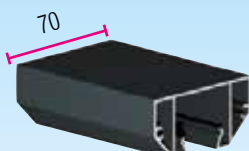

soporte di montaggio per pilastro **CL09**

Altri tipi di montaggio possibili, con il profilo **CL09** al posto dei pali, è possibile fissare le lame su una struttura in calcestruzzo esistente (recinzione rigida)

MONTAGGIO DI LAME

Montaggio Ranch grembiule pieno **PB06** (150)

Nbr. de Lames	Hauteur H.T
3	515
4	665
5	815
6	965
7	1115
8	1265
9	1415
10	1565
11	1715

Diagram showing a fence post with 3 blades. Dimensions: 30mm top offset, 25mm blade thickness, 150mm blade spacing, 35mm bottom offset.

Montaggio Ranch grembiule con giunot **PB06** (150)

Nbr. de Lames	Hauteur H.T
3	565
4	740
5	915
6	1090
7	1265
8	1440
9	1615
10	1790

Diagram showing a fence post with 3 blades and a joint. Dimensions: 30mm top offset, 25mm blade thickness, 175mm blade spacing, 35mm bottom offset.

Montaggio Ranch grembiule con giunot **PB09** (100)

Nbr. de Lames	Hauteur H.T	CL06B ou CL05
4	540	535
5	665	660
6	790	785
7	915	910
8	1040	1035
9	1165	1160
10	1290	1285
11	1415	1410
12	1540	1535
13	1665	1660
14	1790	1785

Diagram showing a fence post with 3 blades and a joint. Dimensions: 30mm top offset, 25mm blade thickness, 125mm blade spacing, 35mm bottom offset.

Montaggio Ranch grembiule pieno **PB09** (100)

Nbr. de Lames	Hauteur H.T	CL06B ou CL05
5	565	560
6	665	660
7	765	760
8	865	860
9	965	960
10	1065	1060
11	1165	1160

Diagram showing a fence post with 3 blades. Dimensions: 25mm blade thickness, 100mm blade spacing.

Montaggio Con vista **CL07** (136)

Nbr. de Lames	Hauteur H.T	CL06B ou CL05
3	478	473
4	614	609
5	750	745
6	886	881
7	1022	1017
8	1157	1152
9	1293	1288
10	1429	1424
11	1565	1560
12	1701	1696
13	1837	1832

Diagram showing a fence post with 3 blades. Dimensions: 30mm top offset, 25mm blade thickness, 135mm blade spacing, 35mm bottom offset.

ST3603A (piede) so-
porte di fissaggio per
palo

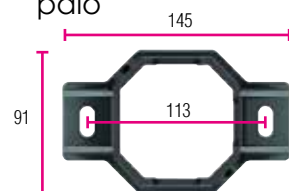

KIT MOTOR SLIDEGATE FIRST (230V)



SOLUCIÓN IDEAL PARA PORTALES CORREDEROS EN RESIDENCIALES **600 KG**

INNOVADOR, RESISTENTE Y FIABLE

El cuidado en el diseño garantiza la máxima precisión, adaptabilidad a cada condición y fiabilidad en el tiempo.

Todos los ejes de transmisión están montados en rodamientos, con un montaje modular.

SLIDEGATE está fabricado para ser fácil de instalar y garantizar la máxima fiabilidad en el tiempo, incluso en condiciones críticas. Desarrollado para garantizar la máxima seguridad y cumplir con la normativa vigente en materia de fuerzas de impacto.

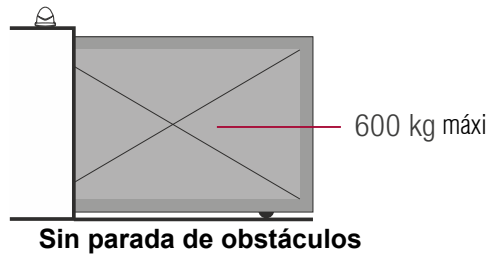

COMPOSICIÓN DEL PACK

					
Motor	Placa	Fotocélulas exteriores con pequeños accesorios para un montaje profesional	Piloto luminoso 230V	cremallera de nylon 20x28x1000 mm con dientes de acero, aletas de fijación y gama de tornillos	Mando a distancia rolling code de 4 canales
Electrónica AUTOMO - SGATE integrada					
ENCOMBREMENT					
PACK 230V	1	1	1	1	4
					2

ESQUEMA INDICANDO LOS ACCESORIOS RECOMENDADOS DURANTE LA INSTALACIÓN DE UNA MOTORIZACIÓN

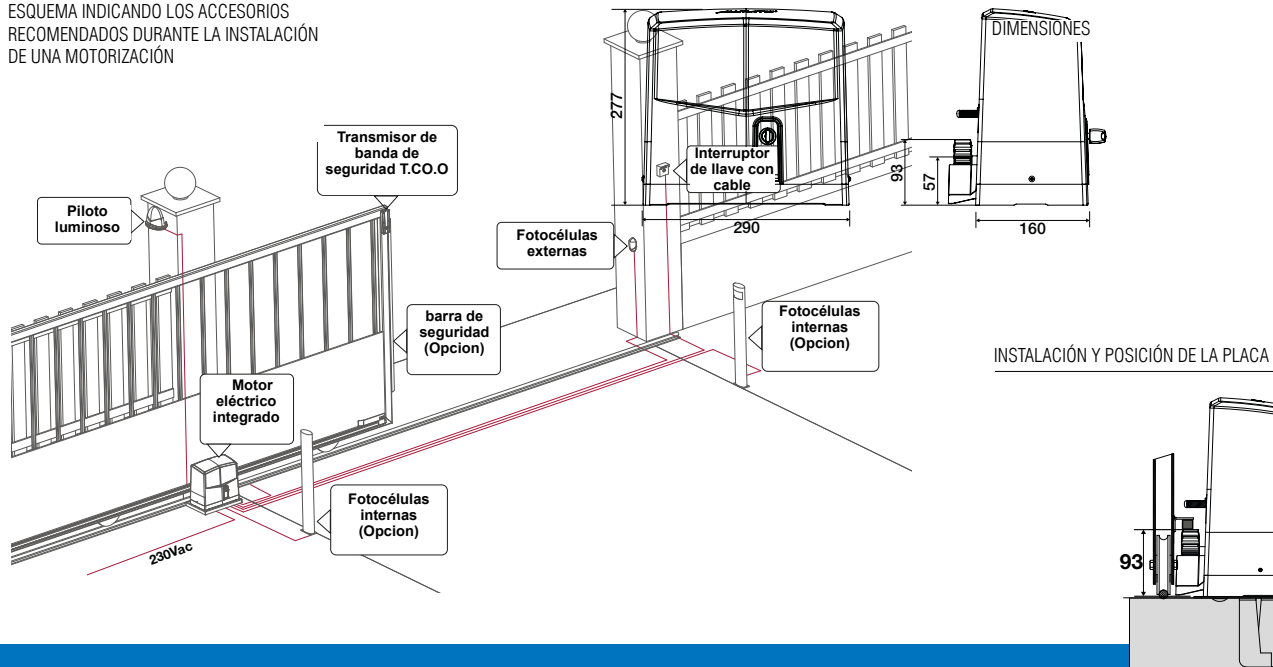

KIT MOTOR SLIDEGATE HOME (24V)

SOLUCIÓN IDEAL PARA PORTALES CORREDEROS EN RESIDENCIALES **700 KG**

INNOVADOR, RESISTENTE Y FIABLE

El cuidado en el diseño garantiza la máxima precisión, adaptabilidad a cada condición y fiabilidad en el tiempo.

Todos los ejes de transmisión están montados en rodamientos, con un montaje modular.

SLIDEGATE está fabricado para ser fácil de instalar y garantizar la máxima fiabilidad en el tiempo, incluso en condiciones críticas. Desarrollado para garantizar la máxima seguridad y cumplir con la normativa vigente en materia de fuerzas de impacto.

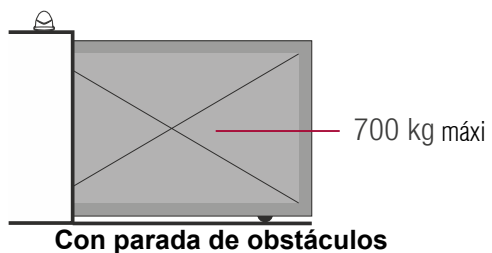

COMPOSICIÓN DEL PACK



Motor

Electrónica AUTOMO - SGATE integrada



Placa



Fotocélulas exteriores con pequeños accesorios para un montaje profesional



Piloto luminoso 24V



cremallera de nylon 20x28x1000 mm con dientes de acero, aletas de fijación y gama de tornillos



Tarjeta cargador de batería de emergencia 24 V enchufe con control electrónico de carga



Kit batería de seguridad. 2 baterías 1.3 Ah



Mando a distancia rolling code de 4 canales

PACK 24V

1

1

1

1

4

1

1

2

EL ESQUEMA INDICANDO LOS ACCESORIOS RECOMENDADOS DURANTE LA INSTALACIÓN DE UNA MOTORIZACIÓN

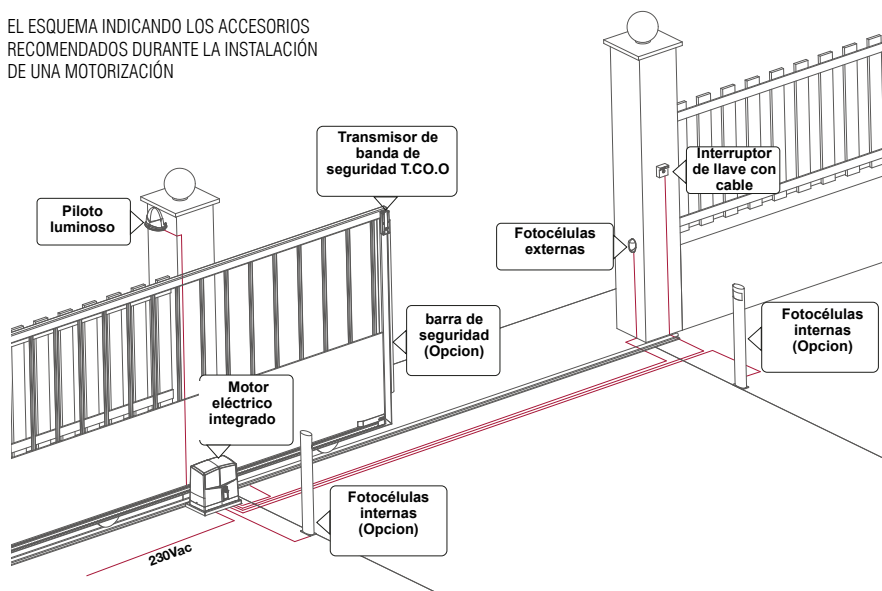

DIMENSIONES

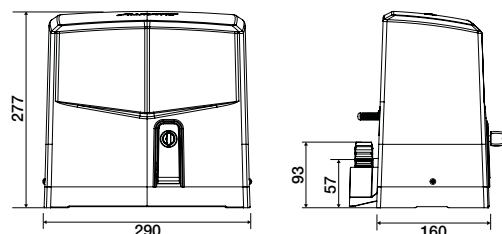

INSTALACIÓN Y POSICIÓN DE LA PLACA

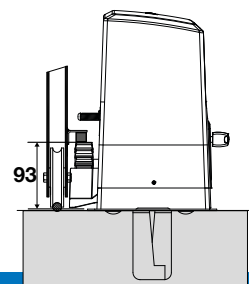

CARACTERÍSTICAS SLIDEGATE FIRST / HOME

CARACTERÍSTICAS TÉCNICAS GENERALES

		SLIDEGATE FIRST 600	SLIDEGATE HOME 24V 700
Peso máximo del portal	kg	600	700
Fuente de alimentación		230Vac 50Hz	230Vac 50Hz
Tensión motor		230Vac 50Hz	24Vdc
Absorción motor	A	1,3	3,5
Condensador	µF	12,5	-
Velocidad	m/min	12	13
Potencia máxima consumida	W	270	75
Fuerza de empuje	N	500	600
Maniobra manual		Manilla de desbloqueo con llave	Manilla de desbloqueo con llave
Panel de programación		3 botones pantalla led de 3 dígitos	3 botones pantalla led de 3 dígitos
Condiciones climáticas de utilización	°C	-20...+60	-20...+60
Frecuencia radio TELCO	MHz	433.92	433.92
Emisores memorizables	Nº	1000	1000
Servicio	%	30	100
Ciclos diarios recomendables	nº	200	400
Ciclos consecutivos garantizados	nº	10	50
Grados de protección	IP	44	44
Probado en		60 000 Ciclos	60 000 Ciclos

CENTRAL DE CONTROL		AUTOMO-SGATE 230	AUTOMO-SGATE 24
CONEXIONES			
Entrada de seguridad con banda de seguridad :		Compatible banda de seguridad mecánica con contacto normalmente cerrado o banda de seguridad resistiva 8k2	Compatible banda de seguridad mecánica con contacto normalmente cerrado o banda de seguridad resistiva 8k2
Entrada de seguridad programable	Tipo	contacto seco : NF	contacto seco : NF
	Compatible	Compatible células fotoeléctricas TX/RX-Células Reflex-Banda de seguridad contacto seco	Compatible células fotoeléctricas TX/RX-Células Reflex – Banda de seguridad contacto seco
Entrada de control por cable		contacto seco : no	contacto seco : no
Salida de iluminación remota		230 Vac - 100 W	24 Vac 25 W
Salida de alimentación de 24V dirigida		Si : Para otras posibles células fotoeléctricas TX/RX y Banda de seguridad	Si : Para otras posibles células fotoeléctricas TX/RX y Banda de seguridad
Salida de alimentación accesorios		24Vdc 4W maxi	24Vdc 5W maxi
Entrada de antena remota		Si	Si
Entrada de batería de seguridad		-	Si
FUNCIONAMIENTO			
Piloto independiente de iluminación remota		Si	Si
Temporizador de iluminación (movimiento)		Programable : 0 s a 900 s	Programable : 0 s a 900 s
Parpadeo previo al movimiento		Programable : 0 s (desactivado) a 10 s	Programable 0 s (desactivado) a 10 s
Modo ventana automática		Si temporizador de cierre programable de 0 s (desactivado) a 900 s	Si temporizador de cierre programable de 0 s (desactivado) a 900 s
Funcionamiento entrada de seguridad	En cierre	Programable	Programable
	En Apertura	Programable	Programable
Sensibilidad a los obstáculos (0=desactivado)		Programable : 0% a 100%	Programable : 0% a 100%
Velocidad normal		-	Programable : 50% a 100%
Velocidad de acoplamiento		Programable : lento o rápido	Programable : 10% a 100%
Potencia motor (par)		Programable : 10% a 100%	-
Amplitud de ralentización		Programable : 0% a 100%	Programable : 0% a 100%
Mando de apertura parcial		Programable : 0% a 100% porcentaje de la carrera	Programable : 0% a 100% porcentaje de la carrera
Arranque progresivo		Si	Si

KIT MOTOR WINGATE FIRST (230V)

ELEGANCIA Y FUNCIONALIDAD EN MOVIMIENTO

Los engranajes metálicos y la linealidad de su forma hacen de este motorreductor la unión perfecta entre la estética y la tecnología. Tecnología mecánica avanzada altamente resistente y eficiente, combinada con una electrónica integrada compatible con la gama de centralitas de control AUTOMO (AUTOMO-WGATE) y con un número incomparable de funciones.



PRÁCTICO, DESBLOQUEO CON LLAVE, DISPONIBLE EN AMBOS LADOS DEL MOTOR



FIABLE: FABRICADO CON MATERIALES DE ALTA CALIDAD, ENGRANAJES METÁLICOS.



FIN DE CARRERA MECÁNICA DE CIERRE

GRÁFICO

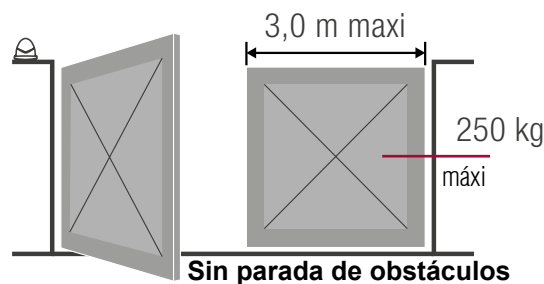
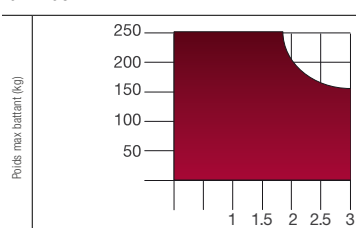

COMPOSICIÓN DEL PACK



MOTOR
Soportes de fijación del motor incluidos en el pack.

AUTOMO-WGATE 230.
Central de control 230V para puertas con 1 o 2 batientes. Transformador integrado.

Piloto intermitente 230V FX

Fotocélula exterior, con pequeños accesorios para una instalación profesional

Mando a distancia rolling code de 4 canales 433Mhz

2	1	1	1	2
---	---	---	---	---

EL ESQUEMA INDICA LOS ACCESORIOS RECOMENDADOS A LA HORA DE INSTALAR UNA MOTORIZACIÓN

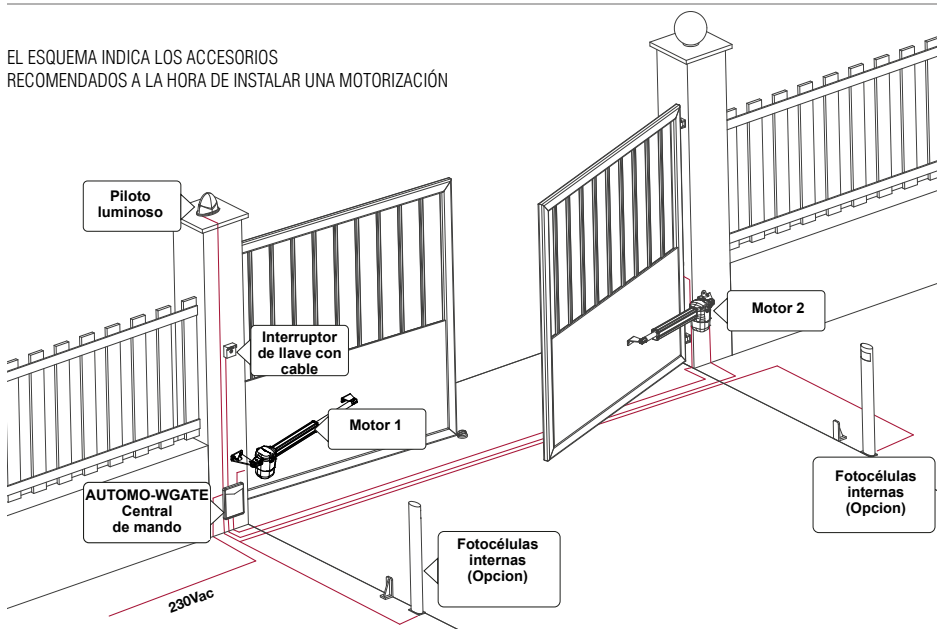

IMPLANTACIÓN C

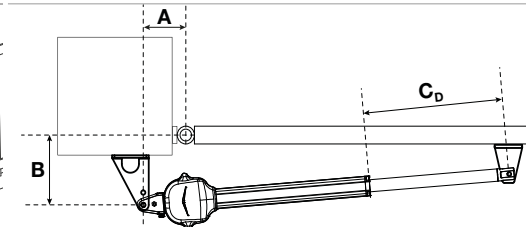

$A + B = C_0$ (carrera utilizable)
 $C_0 =$ (carrera máx disponible) = 400 mm

DIMENSIONES

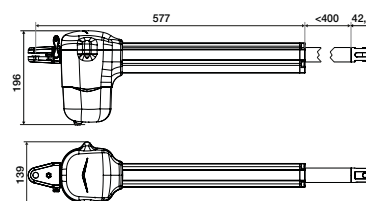

CARACTERÍSTICAS WINGATE FIRST (230V)

CARACTERÍSTICAS TÉCNICAS GENERALES

		WINGATE FIRST 230V
Peso máximo del portal	kg	250
Anchura máxima de la hoja	m	3
Fuente de alimentación		230 Vac - 50Hz
Tensión motor		230 Vac - 50Hz
Absorción motor	A	1
Condensador	µF	10
tiempo de apertura a 90°	sec	15
Potencia máxima consumida	W	200
Fuerza de empuje	N	2000
Condiciones climáticas de utilización	°C	-20...+60
Frecuencia radio TELCO	MHz	433.92
Emisores memorizables	Nº	1000
Servicio	%	50
Ciclos diarios recomendables	nº	100
Grados de protección	IP	55
Probado en		50.000

CENTRAL DE CONTROL		AUTOMO-WGATE 230
CONEXIONES		
Entrada de seguridad con banda de seguridad :		Compatible banda de seguridad mecánica con contacto normalmente cerrado o banda de seguridad resistiva 8k2
Entrada de seguridad programable	Tipo	contacto seco : NF
	Compatible	Compatible células fotoeléctricas TX/RX-Células Reflex-Banda de seguridad contacto seco
Entrada de control por cable		contacto seco : no
Salida de iluminación remota		230 Vac 100 W
Salida de alimentación de 24V dirigida		Si : Para otras posibles células fotoeléctricas TX/RX y Banda de seguridad
Salida de alimentación accesorios		24Vac 9W
Salida cerradura eléctrica		Si i: 12Vac 15VA
Entrada de antena remota		Si ii
Entrada de batería de seguridad		-
FUNCIONAMIENTO		
número de motores		programable : motor 1 / motores 2
Piloto independiente de iluminación remota		Si ii
Temporizador de iluminación (movimiento)		programable : 0 s a 900s
Parpadeo previo al movimiento		Programable : 0 s (desactivado) a 10 s
Modo ventana automática		Si temporizador de cierre programable de 0 s (desactivado) a 900 s
Funcionamiento entrada de seguridad	En cierre	Programable
	En Apertura	Programable
Sensibilidad a los obstáculos (0=desactivado)		Programable: 0% a 100%
Velocidad normal		-
Velocidad de acoplamiento		Programable : lento o rápido
Potencia motor (par)		Programable : 10% a 100%
Amplitud de ralentización		Programable : 0% a 100% porcentaje de la carrera
Mando de apertura parcial		Programable : 1% a 100% porcentaje de la carrera
Golpe de ariete - liberación cerradura eléctrica		Programable: activo-inactivo
comportamiento después del Black Out		Programable: stop - cierre
Desfase hoja		Programable
Inicio progresiva		Si



ORDEN DE COMPRA PORTAIL BATIENTE

Fecha:

Lugar de entrega :
.....
.....
.....

Fecha de entrega deseado :

Referencia de obra :

Nombre del client :

Dirección

NºTelf domicilio :

Nº Telf. Oficina :

SISTEMA

Ciego



Venecianos



Mixto



MEDIDAS EN MILÍMETROS

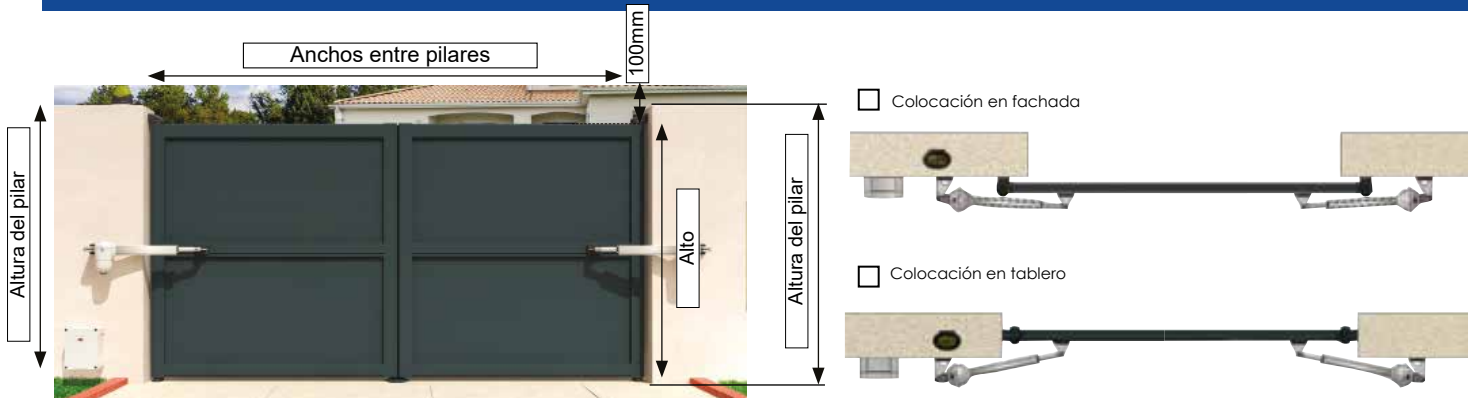

Anchura (ver dimensiones del Kit) mm

Altura (Ver dimensiones del Kit) : mm

MOTORIZACIÓN

- Kit SLIDEGATE FIRST
- Kit SLIDEGATE HOME

POSICIÓN MOTORIZACIÓN

- Derecha- vista desde el interior apertura hacia la Derecha
- Izquierda- Vista desde el interior apertura hacia la Izquierda

OTROS COMENTARIOS

.....
.....
.....

RAL DEFINICIÓN

- RAL 7016 ST
- RAL 9010

ORDEN DE COMPRA

Hecho el :

A :

Firma :



ORDEN DE COMPRA PORTAIL CORREDERO

Fecha:

Nombre del cliente :

Dirección

.....

.....

.....

.....

Nº Telf domicilio :

Nº Telf. Oficina :

Lugar de entrega :

.....

.....

Fecha de entrega deseado :

Referencia de obra :

SISTEMA

Ciego



Venecianos



Mixto



MEDIDAS EN MILÍMETROS

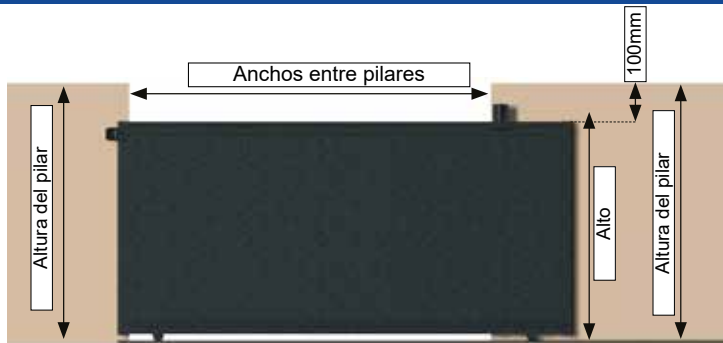

Colocación en fachada



Anchura (ver dimensiones del Kit) mm

mm

Alto (Voir dimension du Kit):

mm

MOTORIZACIÓN

Kit SLIDEGATE FIRST

Kit SLIDEGATE HOME

POSICIÓN MOTORIZACIÓN

Derecha- vista desde el interior apertura hacia la Derecha

Izquierda- Vista desde el interior apertura hacia la Izquierda

OTROS COMENTARIOS

RAL DEFINICIÓN

RAL 7016 ST

RAL 9010

ORDEN DE COMPRA

Hecho el :

A :

Firma :



ORDEN DE COMPRA PUERTAS PEATONALES

Fecha:

Lugar de entrega :
.....
.....
.....

Fecha de entrega deseado :

Referencia de obra :

Nombre del client :

Dirección

.....

.....

.....

.....

NºTelf domicilio :

Nº Telf. Oficina :

SISTEMA

Ciego



Venecianos



Mixto



MEDIDAS EN MILÍMETROS

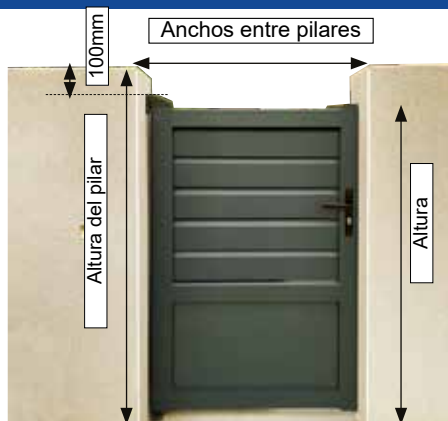

Anchura (ver dimensiones del Kit) mm

Alto (Voir dimension du Kit): mm

POSICIÓNAMIENTO DE FIJACIÓN

- Derecha- vista desde el interior apertura hacia la Derecha
- Izquierda- Vista desde el interior apertura hacia la Izquierda

RAL DEFINICION

- RAL 7016 ST
- RAL 9010

OTROS COMENTARIOS

.....
.....
.....
.....
.....
.....

ORDEN DE COMPRA

Hecho el :

A :

Firma :



ORDEN DE COMPRA PARA VALLAS

Fecha:

Referencia de obra :

Lugar de entrega:

Fecha de entrega deseado:

Nombre del client :
Dirección
.....
.....
Nº Telf domicilio :
Nº Telf. Oficina :

TIPO DE VALLA

Ciego.

PB06

H. Máxi 1715mm

PB09

H. Máxi 1165mm

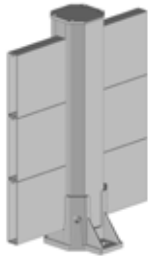

Espaciado

PB06

H. Máxi 1790mm

PB09

H. Máxi 1790mm

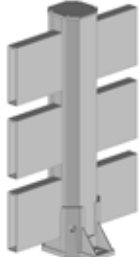

Venecianos

CL07

H. Máxi 2109mm



Información : sellado de 500mm obligatorio para alturas superiores a 1200mm.

FIJACIÓN

Platina para atornillar ST3603

Sellado 300mm

Opción hasta H. 1200mm

Sellado 500mm

Superior a H. 1200mm

COLOCACIÓN ENTRE PILARES - CL09

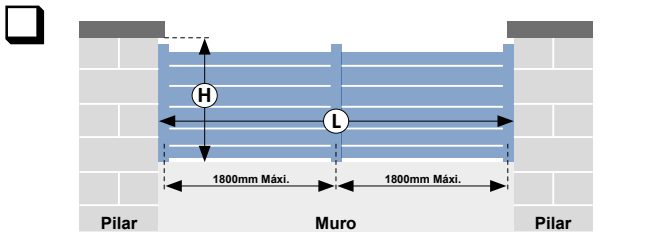

H :
L : RAL :

COLOCACIÓN SIN PILARES - CL06C

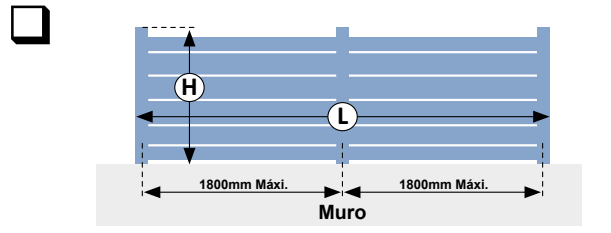

H :
L : RAL :

COLOCACIÓN CON POSTE DE ESQUINA

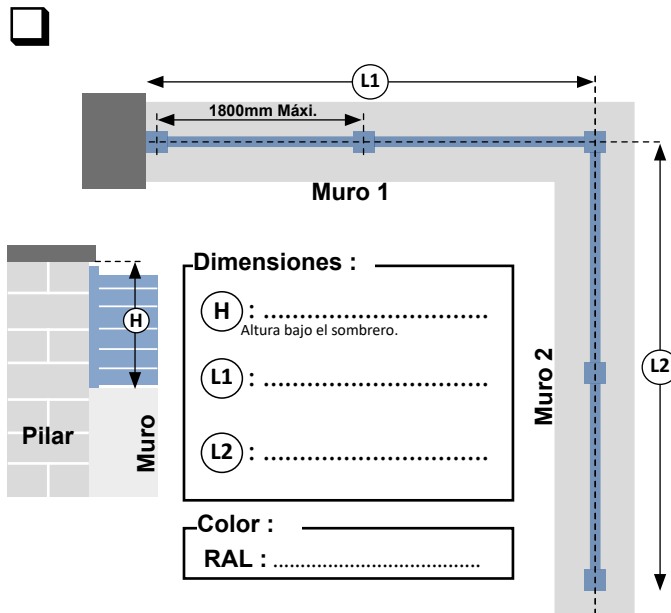

Dimensiones :
H :
L1 :
L2 :
Color :
RAL :

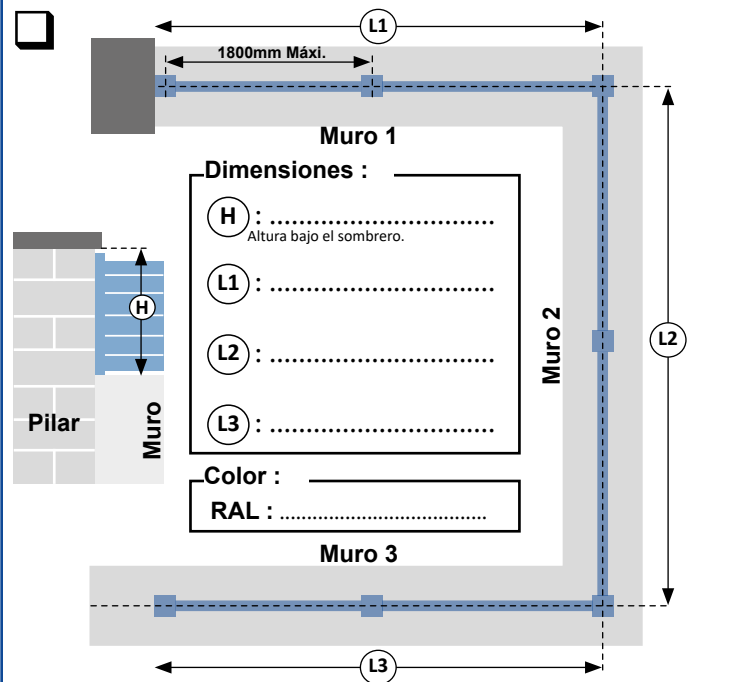

Dimensiones :
H :
L1 :
L2 :
L3 :
Color :
RAL :

ORDEN DE COMPRA

Hecho el : A :

Firma :



ORDEN DE COMPRA PARA VALLAS COLOCACIÓN EN FACHADA

Fecha:

Referencia de obra :

Lugar de entrega:

.....
.....
.....

Nombre del client :

Dirección

.....

.....

.....

NºTelf domicilio :

Nº Telf. Oficina :

Fecha de entrega deseado:

TIPO DE VALLA

Ciego.

PB06

H. Máxi 1115mm

PB09

H. Máxi 1165mm

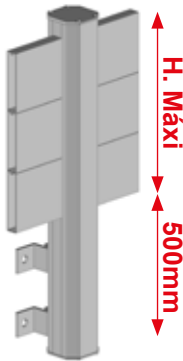

Espaciado:

PB06

H. Máxi 1090mm

PB09

H. Máxi 1165mm

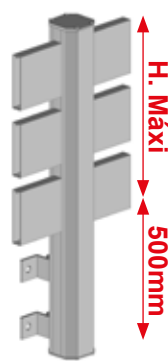

Venecianos

CL07

H. Máxi 1157mm

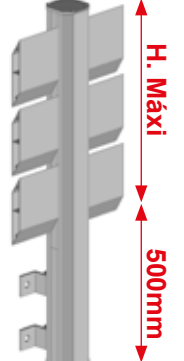

SIN ÁNGULO

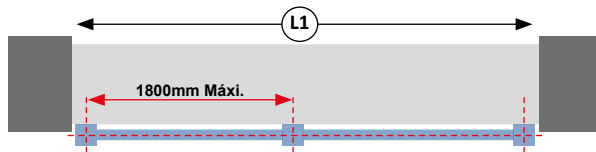

Dimensiones :

(H) :

(L1) :

CON 1 ÁNGULO

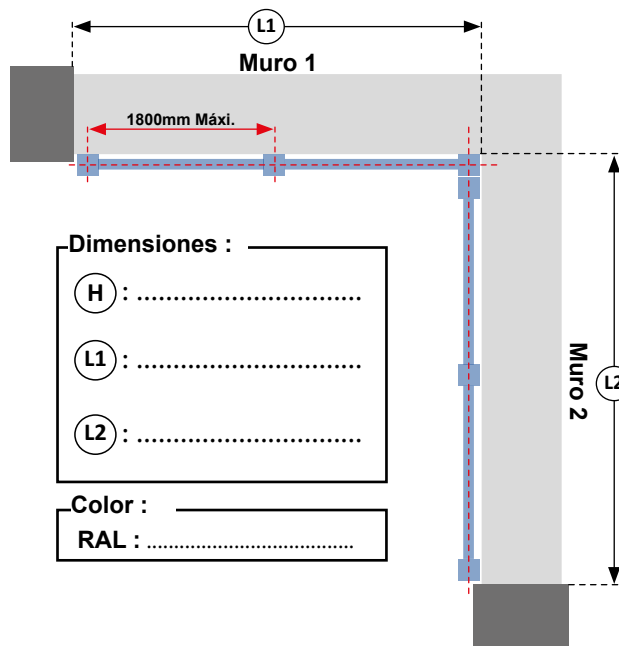

Dimensiones :

(H) :

(L1) :

(L2) :

Color :

RAL :

CON 2 ÁNGULOS

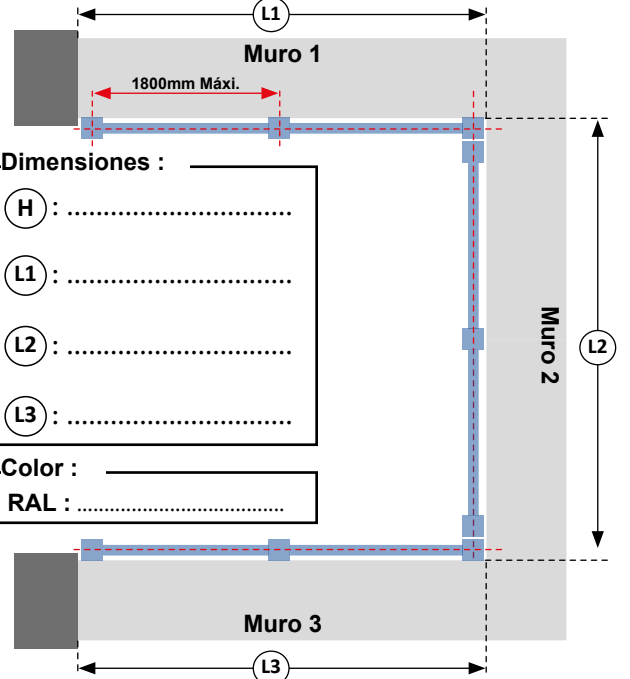

Dimensiones :

(H) :

(L1) :

(L2) :

(L3) :

Color :

RAL :

ORDEN DE COMPRA

Firma :

Hecho el : A :

TERMS AND CONDITIONS

Art 1. Object and scope.

1.1 Any order implies the unreserved acceptance by the buyer and his full and Complete support to the current terms and conditions that prevail upon any other document from the buyer, and especially upon the buyer's terms and conditions unless explicit exceptional agreement is given by our company.

1.2 These terms and conditions shall govern all our product sales unless specific written agreement prior to the order. Consequently, the placement of an order by a customer implies this one's unreserved acceptance of these terms and conditions, unless special conditions granted in writing by our company to the buyer.

1.3 Any other document, apart from these terms and conditions, and especially catalogues, leaflets, advertisements, are only considered as Information and indication, no legally binding.

Art 2. Orders

2.1 DeACABADO By order, we mean any purchase order for our products as stated on our price lists and accepted by our company, possibly along with a deposit as specified on the order form. As soon as an order is received, it has an irrevocable character.

2.2 Amendments

2.2.1 Orders placed to our company cannot be changed by the customer unless otherwise agreed in writing by ourselves. 2.2.2 Any request for amending an order in terms of composition or volume will not be considered as long as it is not in writing including facsimile or e-mail. Two days after the customer receives the acknowledgment receipt of order, no amendment or cancellation of an order will be possible. Should the order be amended, our company will be freed from the agreed delivery times.

Art 3. Prices Our prices are in euro, excluding VAT.

Art 4. Price changes Because of price fluctuations of some raw materials we use, our invoices are issued on the rate of the day when the goods are shipped, our price lists only being a price indication.

Art 5. Transport The goods travel at the risks of the consignee. It is up to the consignee to express reservations on the carrier's delivery slip even though the goods look fine from the outside, so that he can claim to the carrier by registered mail in case of damages not visible at the time of the delivery. In the interest of our customers, shipments are made by the quickest and cheapest way. Express or courier shipments are always made to the customer's expenses.

Art 6. Delivery time

6.1 Delivery times are only given as indicative Fechas. Delays in delivery will not entitle the customer to any penalty nor compensation or to cancel the order. 6.2 Any delay in respect to the announced Fecha of the expected shipment, cannot justify the cancellation of the order placed by the customer and accepted by our company. 6.3 Delivery suspension. In the event of incomplete payment of a matured invoice, and after a 48 hours unheeded notice of default, our company is entitled to stop any current or future delivery.

Art 7. Claims – Returns For custom-made products we cannot accept cancellation or amendment of orders. Any claim for nonconformity will have to be made within 8 days from the receipt of the goods. Our responsibility is limited to the exchange or replacement of the faulty components. No return of goods will be accepted WITHOUT PRIOR AGREEMENT FROM OUR COMPANY. The return of goods will have to be made PACKING AND CARRIAGE PAID, at the latest one month after delivery. Credit notes for return of goods will be under Valor añadido of 30% for handling and depreciation expenses. This under Valor añadido will not be applied when the return is a consequence of our mistake, and in this case the carriage costs will be refunded to you. Credit notes will be deducted from your monthly report. They cannot justify a refusal to pay a previous invoice.

Art 8. Payment terms The prices from a prices lists are made for the following payment terms:

- by 60 day draft end of month; The company Mitjavila is entitled to reduce the payment terms according to financial information about the customer.

- any other mean of payment will be subject to prior agreement from our side.

- in case of payment after the payment deadline indicated on the invoice, but also after the one stated above, a penalty for delay of payment will be charged, calculated by applying to the whole outstanding amount, an interest rate 3 times higher than the legal interest rate.

8.1 Cash payment All orders are accepted considering that the customer has satisfactory financial guarantees and that he will pay the due amounts on time, according to law. If our company has serious or particular reasons to fear payment difficulties from the customer at the time when the order is placed or after that, the acceptance of the order or its implementation can be conditional upon a cash payment or the supply of guarantees in our favour. Our company will be also entitled, before accepting an order as well as during its implementation, to require from the customer accounting documents and particularly profit and loss accounts, even though estimated, that could help to assess its solvency. Should the customer refuse cash payment, without giving satisfactory guarantees, our company could refuse to meet the order(s) and to deliver the goods, without the customer can claim for an unjustified refusal or for compensation whatsoever.

Art 9. Loss of terms The non payment of one of the terms makes the total of the credit in hand immediately payable, 8 days after a notice of default by registered mail with delivery confirmation. In addition, we reserve the right to charge for bank fees or charges that we could bear due to the deferment of the term.

Art 10. Penalty clause Any contentious process will lead to the implementation, as damages, of an indemnity of 15% of the due amount in respect to the articles 1152 and 1226 of the French Civil Code, in addition to all the related legal costs and interests.

Art 11. Reservation of title WE SHALL RETAIN TITLE TO THE GOODS UNTIL FULL PAYMENT OF THE AGREED PRICE. OUR GOODS DELIVERED AND INVOICED REMAIN OUR PROPERTY UNTIL THEIR FULL PAYMENT. IT IS HOWEVER EXPLICITLY PRECISED THAT THE BUYER WILL BE RESPONSIBLE FOR THE GOODS IN HIS HANDS. THE TRANSFER OF POSSESSION INVOLVING THE TRANSFER OF THE RISKS.

Art 12. Refusal of an order In the event of an order placed without having paid the previous order(s), our company will be entitled to refuse the order and to not deliver the goods without any claim for compensation whatsoever could be made by the customer.

Art 13. Place of jurisdiction The choice of the place of jurisdiction is made by the seller at its head office. In case of dispute arising from the implementation of a sale contract or from the payment of a price or regarding the interpretation of the above mentioned articles or conditions, the only competent Commercial Court will be the one from which the company depends whatsoever the place of delivery, the payment terms or in the case of several plaintiffs. Unless other special written convention, all orders imply the unreserved acceptance by the buyer of our terms and conditions, despite any reverse clause mentioned in the buyer's terms and conditions.

CONDICIONES DE VENTA

ARTICULO 1: Los precios que figuran en la presente tarifa están sujetos a variación sin previo aviso, motivado por la posible alteración del coste ó materias primas.

ARTICULO 2: Todos los pedidos, a la recepción de la mercancía deberán ser verificados por el cliente contra cualquier deterioro de los embalajes ó pérdida de algún bulto, haciéndolo constatar en el albarán de la agencia para su reclamación antes de las 48 horas desde la recepción de la mercancía. En el caso de que Ustedes pongan en el albarán (conforme salvo examen) deberán comprobar la mercancía y comunicar cualquier anomalía a la agencia de usted. antes del tiempo referido de las 48 Horas, caso contrario PRODUCCIONES MITJAVILA S.A., declina cualquier responsabilidad, que por éste motivo no quede reflejada en dicho albarán de agencia.

ARTICULO 3: Todos los envíos superiores a 2000,00 euro netos, viajarán a portes pagados por medio de la agencia que en su momento determine Producciones Mitjavila S.A. Cualquier envío que se solicite, por un medio de transporte diferente al estipulado por Producciones Mitjavila S.A. viajará por cuenta del cliente. Isla para la Península.

ARTICULO 4 : Cualquier reclamación sobre la mercancía recibida, no será admitida pasados los 25 días de la recepción de la misma.

ARTICULO 5: Para la devolución de material será imprescindible la comunicación previa a Producciones Mitjavila S.A. antes de realizar la misma y una vez autorizada su devolución deberá realizarse a portes pagados, no aceptando en ningún caso la mercancía devuelta de no reunir éstas condiciones.

ARTICULO 6 : Todos los materiales suministrados por Producciones Mitjavila S.A., tienen una garantía de 3 años. Cualquier accesorios o pieza que sufra rotura motivada por defecto de fabricación será repuesta sin cargo. Siendo por cargo del cliente los gastos de montajes, desmontaje y desplazamiento de la misma.

ARTICULO 7: El I.V.A. es a cargo del comprador.

ARTICULO 8: El comprador se somete a la jurisdicción de los tribunales de Girona.

CONDIÇÕES DE VENDA

ARTIGO 1 : Os artigos, que figuram na presente tarifa, estão sujeitos a variações sem prévio aviso, motivados pela possível alteração do custo das matérias primas.

ARTIGO 2 : Todos os pedidos recebidos pelo cliente, devem ser verificados na data da recepção dos mesmos. No caso de qualquer anomalia no produto ou falta do mesmo, (embalagem perdida), devem comprovar na Guia de Transporte, da Transportadora que procede à entrega do mesmo e de imediato também devem contactar com Mitjavila, S.A..

ARTIGO 3 : Todos os envios superiores a 2 000,00 euros, os portes, serão da responsabilidade da Mitjavila, S.A. Qualquer outro pedido inferior a este valor, será da responsabilidade do cliente e devem ser liquidados à Transportadora no acto da entrega da mercadoria. Alertamos também, que no caso do cliente não se encontrar nas suas Instalações, aquando a Transportadora proceder à entrega do produto e tiver que fazer uma segunda entrega, (ou mais) os portes serão da responsabilidade do cliente, mesmo que a mesma mercadoria, seja superior a 2 000,00 euros.

ARTIGO 4 : Qualquer reclamação sobre a mercadoria recebida, só se aceita devolução no prazo de 8 dias, após, recepção da mesma.

ARTIGO 5 : Para qualquer devolução de material, será imprescindível a comunicação à empresa Mitjavila, S.A., antes de ser realizada a mesma. Uma vez autorizada, deverá ser acompanhada com nota de devolução, referenciando com o (nr) da factura, referências e quantidades. Os portes, devem ser pagos pelo cliente, sempre que a devolução do mesmo não seja motivado por defeito do próprio produto. Em caso algum, será aceite a devolução de mercadoria, sem estas condições apresentadas.

ARTIGO 6 : A mercadoria, viaja por conta e risco do cliente.

ARTIGO 7 : I.V.A. à taxa de 23%.

ARTIGO 8 : Em acaso de Acção Judicial, o Tribunal competente, será da Comarca de Oliveira de Azeméis.



Encuentre todos nuestros productos en nuestros nuevos catálogos.

Para descargar en la página dedicada de nuestro sitio web
www.mitjavila.com



MITJAVILA

GAMA PRODUCTOS

2022



Familia pérgola



Toldos estructuras y lonas



Piezas de Toldos



Toldos de ventanas (screen)



Kits portales y vallas



Carpas y Abris de jardín



Persianas



persianas enrollables



Estructuras solares Fotovoltaica



MITJAVILA

www.mitjavila.com

FRANCE : D900 - Km 7 - B.P.99 - 66602 RIVESALTES Cedex - Tél: (33) 04.68.38.20.00 - Fax: (33) 04.68.38.20.32

FRANCE : 54 BD. des Jardiniers, allée des Pins - 06200 NICE - Tél (33) 04.92.29.18.60 - Fax (33) 04.92.29.18.61

FRANCE : Z. I. Prats - 65260 PIERREFITTE NESTALAS - Tél: (33) 05.62.92.13.95 - Fax: (33) 05.62.92.21.98

FRANCE : Z. I. Point Sud - 65260 SOULOM - Tél: (33) 05.62.92.74.44 - Fax: (33) 05.62.92.79.86

FRANCE : 36 Chemin Latéral - 45 390 PUISEAU - Tél (33) 02.38.34.83.71

ESPAGNE : Pont del Princep, Ctra N II - Km 757 - VILAMALLA (Girona) - Tél: (34) 972.52.61.23 - Fax: (34) 972.52.54.54

ESPAGNE : Ctra de Figueres à Llers S/N - 17730 LLERS (Girona) - Tél : (34) 972.52.80.87 - Fax : (34) 972.52.81.27

ESPAGNE : AVD. de Las canteras 46/48 - P.I. Valmor - 28343 VALDEMORO - Madrid - Tél : (34) 918.75.35.76 - Fax : (34) 918.75.37.23

ESPAGNE : Poligono industrial la Chaparrilla - C/ CHAPARRILLA, 34 Nave 21 - 41016 SEVILLA - Tél : (34) 955.63.11.13

ESPAGNE : Santander CL ALDAY, S/N LA CERRADA - 39600 MALIAÑO - CANTABRIA - Tél : (34) 942 58 26 74

PORTUGAL : Z.I. Nogueira do Cravo - 3720 OLIVEIRA DE AZEMEIS - Tél: (351) 256.86.02.30 - Fax: (351) 256.86.02.31

PORTUGAL : Rua da Industria, Carro Quebrado - 3720 PINDELO - Tél: (351) 256.86.02.36 - Fax: (351) 256.86.02.32

ITALIE : Via della libertà, 118 15060 Vignole Borbera (AL) - Italia - Tel : (39) 0143/1433029

CANADA : 380 Brignon - Granby - Quebec - CANADA - J2G8A2 - Tél: (1) 450.378.0818 - Fax: (1) 450.378.2711

FLORIDE : 2301 PREMIER ROW - ORLANDO FL 32809 - Tel : (407) 857 20 05 - Fax : (407) 857 22 30

CARAÏBES : Z.I. Jaula N° 39 - 97129 LAMENTIN - GUADELOUPE - Tél : (590) 28.25.00 - Fax : (590) 28.24.99

CHILI : El Trigal 5573 - Comona Estación Central - SANTIAGO - Chile - Tél : (562) 742.3846 - Fax : (562) 742.1169



TPCL322-1.85